



# Zames–Falb multipliers for absolute stability: From O'Shea's contribution to convex searches



Joaquin Carrasco<sup>a,\*</sup>, Matthew C. Turner<sup>b</sup>, William P. Heath<sup>a</sup>

<sup>a</sup> Control Systems Centre, School of Electrical and Electronic Engineering, The University of Manchester, Manchester M13 9PL, UK

<sup>b</sup> Control Systems Research Group, Department of Engineering, University of Leicester, Leicester, LE1 7RH, UK

## ARTICLE INFO

### Article history:

Received 27 May 2015

Received in revised form

5 July 2015

Accepted 18 October 2015

Recommended by A. Astolfi

Available online 2 December 2015

### Keywords:

Absolute stability

Slope-restricted nonlinearities

Multiplier theory

## ABSTRACT

Absolute stability attracted much attention in the 1960s. Several stability conditions for loops with slope-restricted nonlinearities were developed. Results such as the Circle Criterion and the Popov Criterion form part of the core curriculum for students of control. Moreover, the equivalence of results obtained by different techniques, specifically Lyapunov and Popov's stability theories, led to one of the most important results in control engineering: the KYP Lemma.

For Lur'e<sup>1</sup> systems this work culminated in the class of multipliers proposed by O'Shea in 1966 and formalized by Zames and Falb in 1968. The superiority of this class was quickly and widely accepted. Nevertheless the result was ahead of its time as graphical techniques were preferred in the absence of readily available computer optimization. Its first systematic use as a stability criterion came 20 years after the initial proposal of the class. A further 20 years have been required to develop a proper understanding of the different techniques that can be used. In this long gestation some significant knowledge has been overlooked or forgotten. Most significantly, O'Shea's contribution and insight is no longer acknowledged; his papers are barely cited despite his original parameterization of the class.

This tutorial paper aims to provide a clear and comprehensive introduction to the topic from a user's viewpoint. We review the main results: the stability theory, the properties of the multipliers (including their phase properties, phase-equivalence results and the issues associated with causality), and convex searches. For clarity of exposition we restrict our attention to continuous time multipliers for single-input single-output results. Nevertheless we include several recent significant developments by the authors and others. We illustrate all these topics using an example proposed by O'Shea himself.

© 2015 European Control Association. Published by Elsevier Ltd. All rights reserved.

## 1. Introduction

A feedback interconnection of a linear system and a static nonlinearity is said to be *absolutely stable* if the interconnection is stable (in some sense) for every nonlinearity in a given class. The theory of absolute stability has occupied an important portion of the control theory literature due to its relevance to a variety of practical control/systems engineering problems. The absolute stability problem can be studied, broadly, from either the perspective of internal stability, or from that of input–output stability. The former, and perhaps more common, approach typically involves the search for the parameters of a proposed Lyapunov function which can be used to guarantee asymptotic stability of

the origin for as large a class of nonlinearities as possible. The latter approach involves the use of transfer functions called *multipliers*. In their classical interpretation they are used to translate one nonlinear passivity-type problem into another linear, easier to solve, passivity-type problem. The aim, again, is to choose a multiplier within a predefined class of multipliers which allows input–output stability to be guaranteed for as large a class of nonlinearities as possible. In this paper, attention is focused on input–output stability from the perspective of passivity and in particular on the properties of the so-called Zames–Falb multipliers.

The multiplier approach attracted much attention from the control community in the 1960s. One reason for this was, without the computing power of today, researchers were able to glean a great deal about the absolute stability of a system purely from the properties of the linear part. In an early paper the concept of multiplier was used by Brockett and Willems [9] and the idea developed rapidly from this (see [58]). Despite this early promise and flurry of activity, probably the most widely known absolute

\* Corresponding author.

E-mail addresses: [joaquin.carrascogomez@manchester.ac.uk](mailto:joaquin.carrascogomez@manchester.ac.uk) (J. Carrasco), [mct6@le.ac.uk](mailto:mct6@le.ac.uk) (M.C. Turner), [william.heath@manchester.ac.uk](mailto:william.heath@manchester.ac.uk) (W.P. Heath).

<sup>1</sup> Also written as Lur'e or Lurie.

stability tools today are the Circle and Popov Criteria (see [79,38]) which have become standard, in part due to their simplicity and in part due to their graphical interpretations. However, when a tighter description of the nonlinearity is available, these criteria are well-known to be conservative. In such cases, the use of more general multiplier methods can be useful and, in particular, the so-called Zames–Falb multipliers can often be used to improve predictions made about stability and performance of the interconnection.

Despite their moniker, Zames–Falb multipliers were actually discovered by O’Shea (his portrait is shown in Fig. 1) in [59,60]. While the treatment of O’Shea [59] was restricted to causal multipliers, the aim of [60] was to extend this definition to noncausal multipliers: “this modification allows greater freedom in the phase variation of  $G(j\omega) + 1/k$  outside of the  $\pm 90^\circ$  band”. There were several correspondence items discussing these [88,85,23]. A rigorous and correct treatment was first given in the much-cited paper by Zames and Falb [89]. The contribution of O’Shea was fully acknowledged by all concerned at the time. As an example, Desoer and Vidyasagar [22] state that the “idea of using noncausal multipliers is due to O’Shea.”



Fig. 1. R.P. O’Shea, reproduced with kind permission of [71].

However, the class of multipliers aroused little further interest for 20 years, until the proposal of Safonov and Wyetzner [65] for computer-aided search and the illustration by Megretski and Rantzer [54] of multiplier analysis embedded within the framework of IQCs. In these and subsequent papers the pioneering work of O’Shea was largely overlooked. The terminology “Zames–Falb multiplier” appears to have been coined by Chen and Wen [18,19] in their proposal for a convex search. This development, while rightly acknowledging the important work of Zames and Falb, has had an unfortunate consequence. Zames and Falb [89] focus on the relation of the nonlinearity to the monotone and bounded static nonlinearity; O’Shea’s insights into the phase properties of the multipliers have been largely forgotten (with one notable exception: the discussion of Megretski [51] on phase limitation).

In this tutorial paper we re-examine Zames–Falb multipliers and, in particular, use an example of O’Shea [60] to discuss the phase properties of the Zames–Falb multipliers and how they can be used advantageously in the study of the absolute stability problem.

The remainder of the paper is structured as follows. In Section 2 we provide a brief motivating example explaining the significance of Zames–Falb multipliers, and in Section 3 we review the basics of the absolute stability problem and some approaches to its solution. In Section 4 we address at length an example previously discussed by O’Shea [60]. In particular we discuss how a number of input–output stability methods can be used for analysis. This section includes a comprehensive treatment of the application of a multiplier originally proposed by O’Shea. In Section 5 further properties of Zames–Falb multipliers are discussed and in Section 6 a brief review of start-of-the-art computational searches is given. Further developments of Zames–Falb multipliers are discussed in Section 7 and open questions considered in Section 8. Finally in Section 9 we conclude and point to some other recent developments in the use of Zames–Falb multipliers. While we emphasise the tutorial aspect of this overview, some mathematical formalism and machinery is inevitable; this is given in the appendix.

## 2. Motivating example

**Remark 1.** Several concepts in this section are formally defined in Section 3 and/or the Appendix.

Since saturation is a memoryless and slope restricted nonlinearity, the Zames–Falb multipliers can be used to study the stability/robust stability of systems involving saturation [34]. We shall illustrate such analysis with an anti-windup example [39] where robust stability is to be established [73,55].  $U(s)$  and  $Y(s)$  are the Laplace transform of the plant’s input and output, respectively.

Consider a plant with additive uncertainty

$$Y(s) = \left( G(s) + \frac{1}{\gamma} \Delta \right) U(s), \quad (1)$$

where  $G(s)$  is the nominal SISO transfer function and  $\Delta$  represents additive uncertainty with, for any bounded signal  $u$ ,

$$\| \Delta u \|_2 \leq \| u \|_2. \quad (2)$$

In the case where  $\Delta$  is restricted to be a linear time invariant (LTI) system we may write this as the familiar  $H_\infty$  norm condition

$$\| \Delta \|_\infty \leq 1. \quad (3)$$

Suppose the controller has the internal model control structure given by

$$U(s) = -Q(s)(Y(s) - G(s)U(s)). \quad (4)$$

and illustrated in Fig. 2.

The robustness of such controllers is discussed at length by Morari and Zafriou [56]. Briefly, if both  $G$  and  $Q$  are stable, then it follows from a small gain argument that the loop is stable provided

$$\| Q \|_\infty < \gamma. \quad (5)$$

Suppose now there is saturation in the loop, as in Fig. 3. Since the saturation operator is in series with  $\Delta$ , a similar small gain argument [73] says that the loop remains stable provided (5) is

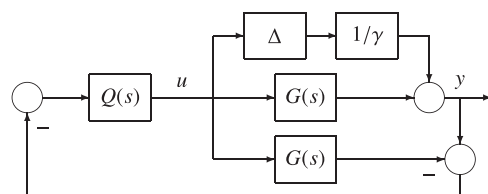

Fig. 2. Internal model control where the plant dynamics are assumed known save for an additive uncertainty.

satisfied. In other words, the antiwindup scheme preserves the robustness (to additive uncertainty) of the loop without saturation.

But the antiwindup scheme of Fig. 3 can be notoriously sluggish. To improve matters, one suggestion in the literature [90] is the scheme of Fig. 4 with

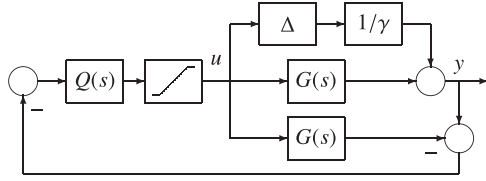

Fig. 3. Internal model control with saturation.

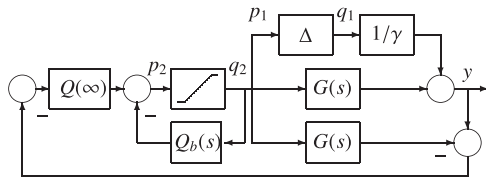

Fig. 4. The antiwindup scheme of Zheng et al. [90].

$$Q_b(s) = \frac{Q(\infty)}{Q(s)} - 1, \quad (6)$$

so that

$$Q(s) = (1 + Q_b(s))^{-1} Q(\infty). \quad (7)$$

This often has much better performance, but there is no longer an *a priori* guarantee of stability. In our example we consider a case where the Zames–Falb multipliers can be used to establish such stability.

Suppose  $G$  is first order with a delay (a standard model in the process industries):

$$G(s) = e^{-sd} \frac{b}{s+a}. \quad (8)$$

A natural choice for  $Q$  is then:

$$Q(s) = \frac{cs+a}{bs+c}. \quad (9)$$

In the unconstrained (saturation  $\equiv$  identity) case, robust stability is established via (5) which in this case reduces to

$$\max\left(\frac{c}{b}, \frac{a}{b}\right) < \gamma. \quad (10)$$

In the constrained (saturation  $\neq$  identity) case, establishing robust stability is much more difficult. However the constrained loop is stable [55] provided there exists a multiplier (of some form)  $M$  such that

$$1 - Q_b^* M^* - M Q_b - M - M^* + M^* M Q(\infty)^2 / \gamma^2 < 0, \quad (11)$$

at all frequencies. It may not be possible to satisfy this inequality with a constant  $M$  (and it cannot be satisfied with constant  $M$  if  $\|Q\|_\infty \rightarrow \gamma$ ), but for our example, it is straightforward to check that the inequality is satisfied if we choose

$$M(s) = \frac{s+a}{s+c}. \quad (12)$$

It transpires that this belongs to the class of first order Zames–Falb multipliers provided  $0 < a < 2c$ . In this case the robust stability of the constrained loop is established using a Zames–Falb multiplier.

### 3. Preliminaries

In an early paper, Brockett and Willems [9] use the concept of a multiplier. The aim of its use is to reduce the conservatism of the open loop approach which is used to analyse the stability of the problem. The advantage of this approach is that the condition to be tested will only depend on the linear system  $G$  and the maximum slope of the nonlinearity  $k$ .

#### 3.1. The Lur’e problem

The Lur’e problem consists of finding conditions on the linear system  $G$  such that the feedback interconnection between  $G$  and any nonlinearity  $\phi$  that belong to some class of nonlinearities is stable. As stability must be ensured for the whole class, the adjective *absolute* is added, and this problem is also known as the absolute stability problem (see [47] for an overview).

The feedback interconnection in Fig. 5 is defined by

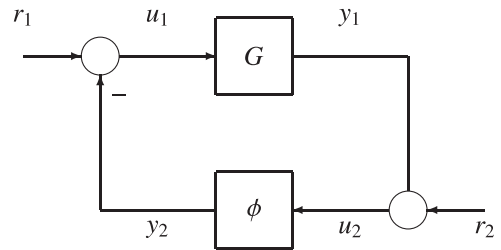

Fig. 5. Lur’e system. Both  $G$  and  $\phi$  are assumed to be causal.

$$\begin{cases} u_1 = r_1 - \phi u_2, \\ u_2 = r_2 + G u_1. \end{cases} \quad (13)$$

It is usual, although not necessary, to assume that  $G$  is strictly proper. This is enough to ensure the feedback between  $G$  and any slope-restricted nonlinearity is well-posed (i.e. that  $u_1$  and  $u_2$  are uniquely defined given  $r_1$  and  $r_2$ , all on the extended spaces defined in the appendix). The system is said to be input/output stable if for any  $r_1 \in \mathcal{L}_2$ ,  $r_2 \in \mathcal{L}_2$  we also have  $u_1 \in \mathcal{L}_2$  and  $u_2 \in \mathcal{L}_2$ .

In this paper we consider the class of static nonlinearities with slope less than or equal to  $k$ . With an abuse of notation we use  $\phi$  to denote both the memoryless operator ( $\phi : \mathcal{L}_{2e} \rightarrow \mathcal{L}_{2e}$ ) and its associated nonlinear function  $\phi : \mathbb{R} \rightarrow \mathbb{R}$ .

**Definition 1.** A static nonlinearity  $\phi$  is said to be slope restricted  $\phi \in S[0, k]$  if for any real number  $x$  and  $y$  we have

$$0 \leq \frac{\phi(x) - \phi(y)}{x - y} \leq k. \quad (14)$$

The Linear Time Invariant (LTI) system  $G$  is given by

$$\dot{x} = Ax + Bu, \quad (15)$$

$$y = Cx + Du, \quad (16)$$

and its transfer function is  $G(s) = C(sI - A)^{-1}B + D$ . Henceforth, we will no longer distinguish between LTI operators and their transfer functions. The Rosenbrock system matrix

$$G(s) \sim \begin{bmatrix} A & B \\ C & D \end{bmatrix} \quad (17)$$

will be used as shorthand.  $G^*$  denotes the adjoint of  $G$  and it is given by  $G^*(s) = G^*(-s)$ .

We assume  $G$  is stable (i.e.  $A$  is Hurwitz); hence we may assume  $r_1 = 0$  without loss of generality. If  $G$  is unstable, the loop would be unstable with  $\phi$  being the zero operator.

### 3.2. The Nyquist value and the Kalman conjecture

The class of slope restricted nonlinearities  $\phi \in S[0, k]$  includes the linear gains  $\tau k$  with  $\tau \in [0, 1]$ . This provides some insight to the absolute stability problem. In particular it is *necessary* for absolute stability that the Lur'e system be stable with any such linear gain. The Nyquist value  $k_N$  is the maximum value of  $k$  for which this holds:

**Definition 2 (Nyquist value).** Let  $G \in \mathbf{RH}_\infty$  with Rosenbrock system matrix (17). The Nyquist value is given by

$$k_N = \sup \{ k > 0 : A - \tau B C k (1 + \tau k D)^{-1} \text{ is Hurwitz for all } \tau \in [0, 1] \}. \quad (18)$$

It is tautologous to say that for absolute stability we require  $k < k_N$ . As a result, the inverse of the linear system  $(1 + \tau k G)$  needs to be bounded for all  $\tau \in [0, 1]$ . This fact implies that for absolute stability to hold the phase of the system  $(1 + kG)$  must be within the interval  $(-180^\circ, 180^\circ)$ .

Kalman [35] made the conjecture that consideration of feedback with linear gain was also *sufficient* for absolute stability:

**Kalman Conjecture [35].** Let  $\phi$  be a memoryless nonlinearity slope-restricted on  $S \in [0, k]$ . Then, the Lur'e system in Fig. 5 is asymptotically stable if  $A - \tau B C k (1 + \tau k D)^{-1}$  is Hurwitz for all  $\tau \in [0, 1]$ .

The conjecture has played an important part in the development of the absolute stability of feedback systems containing slope-restricted nonlinearities. It is true for first, second and third-order continuous-time systems [8]. Thus we know *a priori* that a third order system is absolutely stable provided  $\phi \in S[0, k_N]$  and we can benchmark a test for stability by seeking the maximum slope value and comparing with this upper bound (e.g. [65,16]). But the conjecture is false in general and the fourth-order counterexamples proposed more than 40 years ago [26,60,82,46] can also be used as benchmarks as they can be very challenging for stability tests. We illustrate such a benchmark in this paper.

### 3.3. Passivity, loop transformations and multipliers

Passivity theory provides an important stability test for closed-loop systems. Conditions for stability are simplified since one element of the Lur'e system (13) is LTI and stable. We can assume that  $r_1 = 0$  without loss of generality. It is sufficient for closed-loop stability that  $\phi$  be passive and  $G$  be strictly input passive (SIP). A stable operator  $\phi : \mathcal{L}_2 \rightarrow \mathcal{L}_2$  is said to be passive<sup>2</sup> if there exists some  $\beta \leq 0$  such that  $\langle \phi u, u \rangle \geq \beta$  for all  $u \in \mathcal{L}_2$ .

A stable LTI system  $G$  is SIP [10] if and only if there is a  $\delta > 0$  such that  $\text{Re}\{G(j\omega)\} \geq \delta$  for all  $\omega$ .

If the nonlinearity  $\phi$  is sector bounded on the interval  $[0, k]$  then the map from  $\tilde{u}_2 = u_2 - y_2/k$  to  $y_2$  is passive. But the system shown in Fig. 6 is stable if and only if our original Lur'e system is stable. Hence, via a loop transformation argument, it is sufficient for stability for  $G + 1/k$  to be SIP. This is the Circle Criterion.

Similarly, suppose  $M$  (a “multiplier”) is a biproper transfer function whose zeros and poles are all in the left half plane. Then

the system shown in Fig. 7 is stable if and only if our original Lur'e system is stable. If  $\phi M^{-1}$  is passive, then it suffices for stability that  $MG$  be SIP.

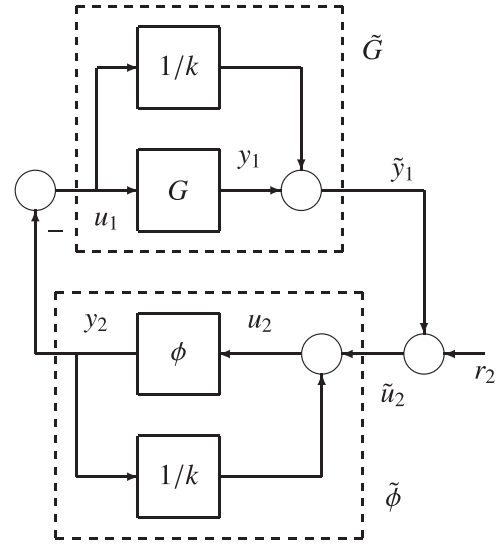

**Fig. 6.** Loop transformation. If the map  $\tilde{\phi}$  from  $\tilde{u}_2 = u_2 - y_2/k$  to  $y_2$  is passive, then it suffices for stability to test whether  $\tilde{G} = G + 1/k$  is strictly input passive, where  $\tilde{y}_1 = y_1 + u_1/k$ .

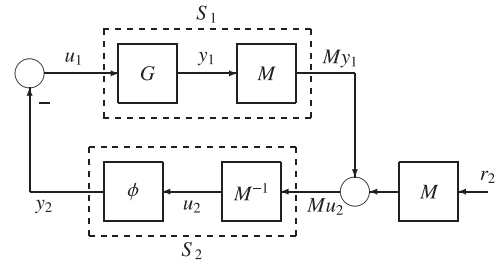

**Fig. 7.** Multiplier theory. If the map  $S_1 = \phi M^{-1}$  is passive then it suffices for stability to test whether  $S_2 = MG$  is strictly input passive.

### 3.4. Zames–Falb theorem

O’Shea [59,60] proposed a set of multipliers appropriate for slope-restricted nonlinearities. This included an extension to *noncausal* multipliers. The machinery was formalized by Zames and Falb [89] in their seminal paper.

**Theorem 1 (Zames et al. [89]).** Consider the feedback system in Fig. 5 with  $G \in \mathbf{RH}_\infty$ , and a slope-restricted nonlinearity  $\phi \in S[0, k]$ . Assume that the feedback interconnection is well-posed. Then suppose that there exists a convolution operator  $M : \mathcal{L}_2(-\infty, \infty) \rightarrow \mathcal{L}_2(-\infty, \infty)$  whose impulse response is of the form

$$m(t) = \delta(t) - \sum_{i=1}^{\infty} h_i \delta(t - t_i) - h(t), \quad (19)$$

where  $\delta$  is the Dirac delta function and

$$\sum_{i=1}^{\infty} |h_i| < \infty, \quad h \in \mathcal{L}_1, \quad \text{and} \quad t_i \in \mathbb{R} \quad \forall i \in \mathbb{N}. \quad (20)$$

Assume that:

$$(i) \quad \|h\|_1 + \sum_{i=1}^{\infty} |h_i| < 1, \quad (21)$$

<sup>2</sup> General definitions of passivity are given by [10,38].

- (ii) either  $h(t) \geq 0$  for all  $t \in \mathbb{R}$  and  $h_i \geq 0$  for all  $i \in \mathbb{N}$ , or  $\phi$  is odd; and
- (iii) there exists  $\delta > 0$  such that

$$\operatorname{Re}\{M(j\omega)(1+kG(j\omega))\} \geq \delta \quad \forall \omega \in \mathbb{R}. \quad (22)$$

Then the feedback interconnection (13) is  $\mathcal{L}_2$ -stable.  $\square$

The corresponding class of multipliers is known as the class of Zames–Falb multipliers.

**Definition 3.** The class of Zames–Falb multipliers  $\mathcal{M}$  is given by all transfer functions  $M \in \mathbf{L}_\infty$  whose inverse Laplace transform<sup>3</sup> is given by

$$m(t) = \delta(t) - \sum_{i=1}^{\infty} h_i \delta(t-t_i) - h(t), \quad (23)$$

where

$$\|h\|_1 + \sum_{i=1}^{\infty} |h_i| < 1. \quad (24)$$

This class will be used for slope-restricted and odd nonlinearities. If the nonlinearity is non-odd, only a subclass of multiplier can be used.

**Definition 4.** The class of positive Zames–Falb multipliers  $\mathcal{M}_+$  is given by all transfer function  $M \in \mathcal{M}$  such that the inverse Laplace transform (23) satisfies that  $\varpi^{-1}(1-M) = h(t) \geq 0$  for all  $t \in \mathbb{R}$  and  $h_i \geq 0$  for all  $i \in \mathbb{N}$ .

Although such definitions may appear formidable at first sight, it is usual to consider only subclasses. Most searches are restricted to rational Zames–Falb multipliers (the class  $\mathcal{RM}$ ), where  $h_i = 0$  for all  $i$  and  $M \in \mathbf{RL}_\infty$ . An exception is the search of [65] where instead  $h(t) = 0$  for all  $t$ , so the multiplier is a sum of delayed impulses.

In addition, if  $M$  is a Zames–Falb multiplier we can always find a factorization  $M = M_a M_c$  where  $M_c, M_c^{-1} \in \mathbf{H}_\infty$  and  $M_a, M_a^{-1} \in \mathbf{H}_\infty^-$ , i.e.  $M_a^*, (M_a^*)^{-1} \in \mathbf{H}_\infty$ . This is the cornerstone of [89] to formalize the use of the class of multiplier proposed by [60]. In the jargon, this factorization is referred to as a canonical factorization (see [13], and the references therein).

It is emphasized that the causality assumption of the real systems  $G$  and  $\phi$  is not required on the multiplier, since it is just a mathematical “device”. Hence  $M$  is not required to be causal. It is required to be bounded in the sense that its impulse response has finite  $\mathcal{L}_1$ -norm (24). In particular this ensures that  $M$  can be factorized into a causal and bounded operator  $M_c$  and an anticausal and bounded operator  $M_a$ . For LTI systems, the use of the bilateral Laplace transform leads to duality properties.<sup>4</sup> Loosely speaking, if a system is assumed to be causal,  $M \in \mathbf{H}_\infty^-$  means that the impulse response of the system is unbounded; if a system is assumed to be bounded,  $M \in \mathbf{H}_\infty^-$  means that the impulse response  $m(t)$  is zero for all  $t > 0$ .

It can be shown that the  $\mathcal{L}_1$  norm condition (21) on  $M$  and the slope-restriction on  $\phi$  ensures

$$\langle y_2, M\tilde{u}_2 \rangle \geq 0. \quad (25)$$

This guarantees the block  $S_2$  in Fig. 7 to be positive. Similarly, the phase property on  $M(G+1/k)$  (22) ensures

$$\langle M\tilde{y}_1, u_1 \rangle \geq 0. \quad (26)$$

Nevertheless, stability cannot be ensured since  $M$  is not causal. Zames and Falb used the canonical factorization  $M = M_a M_c$  to show stability. The properties of the inner product in Eqs. (25) and (26) mean we can write

$$\langle M_a^* y_2, M_c \tilde{u} \rangle \geq 0, \text{ and } \langle M_c \tilde{y}_1, M_a^* u_1 \rangle \geq 0. \quad (27)$$

As a result, both the blocks  $S_1$  and  $S_2$  in Fig. 8 are stable and positive, and hence passive. Therefore, the feedback interconnection between  $S_1$  and  $S_2$  is stable (by passivity) and equivalent to our original Lur’e problem.

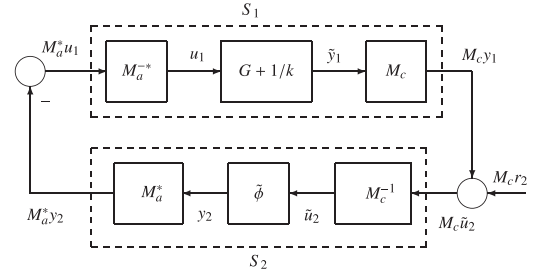

**Fig. 8.** Combination of the loop transformation in Fig. 6, multiplier approach in Fig. 7, and factorization  $M = M_a M_c$ . All LTI blocks are in  $\mathbf{H}_\infty$ . The structure is used to justify noncausal multipliers.

#### 4. O’Shea’s example

Our standard problem is the Lur’e problem (13) depicted in Fig. 5. The nonlinearity  $\phi$  from  $u_2$  to  $y_2$  is static and slope-restricted to the interval  $S[0, k]$ .

Brockett and Willems [9] suggested plants with the structure

$$G(s) = \frac{s^2}{s^4 + as^3 + bs^2 + cs + d}, \quad (28)$$

would be challenging to analyse. O’Shea [60] chose a subclass of the form

$$G(s) = \frac{s^2}{(s^2 + 2\zeta s + 1)^2}, \quad (29)$$

where the symmetry aids both intuitive understanding and the ability to find solutions by hand. The symmetry is given by  $G(j\omega) = G^*(j\omega^{-1})$ . This turns out to be a challenging feature for several classes of multipliers.

If the nonlinearity  $\phi$  is replaced with a linear gain  $k$ , then the loop is stable for all  $k$  and for all  $0 < \zeta \leq 1$ ; i.e. the Nyquist value is infinite when  $\zeta$  is in this range (the phase never drops below  $-180^\circ$ , see Fig. 12). But if  $\phi$  is a saturation block in series with a gain  $k$ , then it is possible to find values of  $k$  and  $\zeta$  that are apparently unstable. For example, Fig. 9 shows the result generated in Simulink when  $\zeta = 0.1$  and  $k = 2000$ . Such phenomena were first observed by Fitts [26], and have attracted much attention as counterexamples to the Kalman conjecture. Barabanov [8] questioned the validity of Fitts’ original counterexample; this has led to considerable discussion [45,43,46]. O’Shea [61] showed that such loops could be guaranteed stable for all  $k > 0$  provided  $1/2 < \zeta \leq 1$ . For most of our discussion we will fix  $\zeta = 0.6$ . Fig. 10 shows such stable behavior generated in Simulink when  $\zeta = 0.6$  and  $k = 2000$ .

In the following subsections, we will consider how various standard criteria can be used to judge stability. In particular we will be able to associate a particular range of  $k$  for each criterion where stability can be guaranteed.

<sup>3</sup> Since  $m : \mathbb{R} \rightarrow \mathbb{R}$ , the bilateral Laplace transform is required.

<sup>4</sup> It also leads to intrinsic difficulties [29].

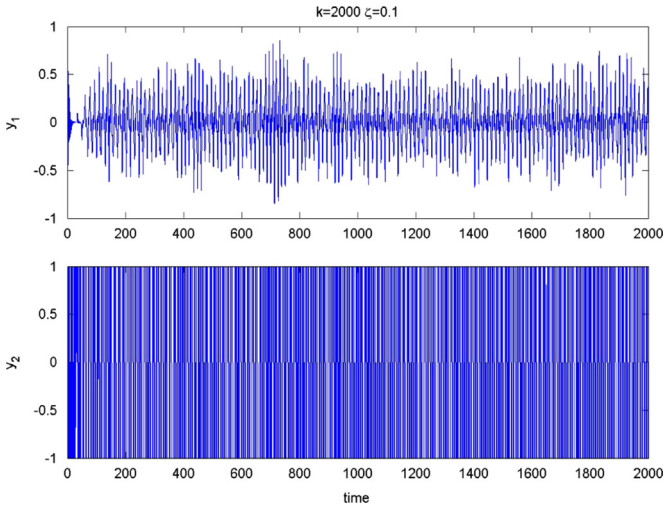

**Fig. 9.** Simulated values for signals  $y_1$  and  $y_2$  when  $k = 2000$  and  $\zeta = 0.1$ . The loop is apparently unstable.

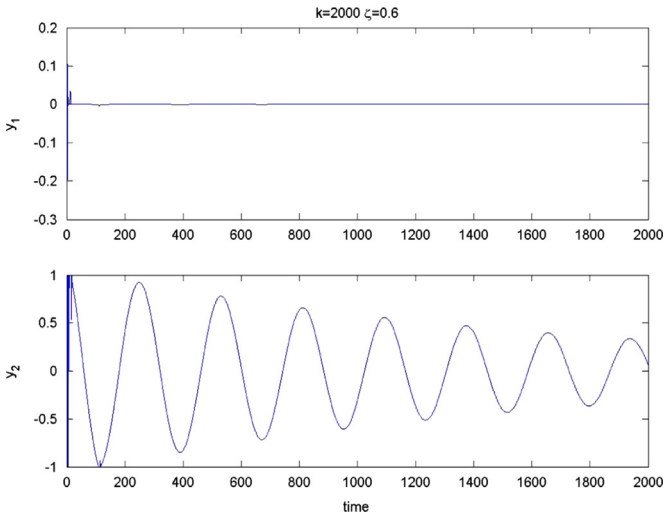

**Fig. 10.** Simulated values for signals  $y_1$  and  $y_2$  when  $k = 2000$  and  $\zeta = 0.6$ . The loop is apparently stable, and O'Shea's analysis proves it to be.

#### 4.1. Passivity

In our problem the nonlinearity  $\phi$  from  $u_2$  to  $y_2$  is passive. It would therefore suffice for the phase of  $G$  to lie on the interval  $(-90^\circ, +90^\circ)$ . However  $G$  is *not* passive; its phase approaches  $+180^\circ$  at low frequency and  $-180^\circ$  at high frequency (Fig. 12). Hence the passivity theorem cannot be used directly to establish stability for any  $k > 0$ .

#### 4.2. Small gain theorem

The  $\mathcal{L}_2$  gain of the nonlinearity from  $u_2$  to  $y_2$  is  $k$ . That is to say, for any  $u_2 \in \mathcal{L}_2$ , we must have  $\|y_2\|_2 \leq k\|u_2\|_2$ . It follows by the small gain theorem that the loop is guaranteed stable provided

$$k\|G\|_\infty < 1.$$

The  $H_\infty$  norm of  $G$  is  $\|G\|_\infty = 0.6944$  (see Fig. 11). Hence we may conclude the loop is stable for

$$k < \frac{1}{0.6944} = 1.44.$$

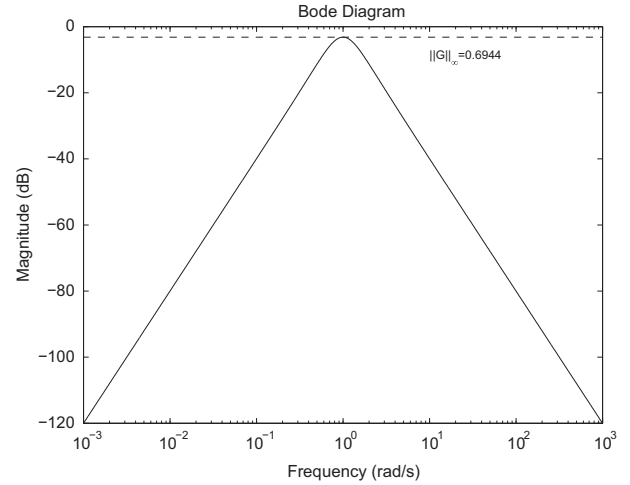

**Fig. 11.** The  $H_\infty$  norm of  $G$  is 0.6944.

#### 4.3. Circle Criterion

Although the passivity theorem cannot be invoked directly, it can be used indirectly. The nonlinearity  $\phi$  is sector bounded; it follows we can use a loop transformation and apply the Circle Criterion (Fig. 6). It is thus sufficient for  $G+1/k$  to be SIP for stability. For our example we find (Fig. 12)

$$\operatorname{Re}\{G(j\omega)\} > -0.0868 \quad \text{for all } \omega.$$

It follows that the loop is stable provided

$$k < \frac{1}{0.0868} = 11.52.$$

#### 4.4. Popov Criterion

For the Popov Criterion we test whether  $M(G+1/k)$  is SIP where  $M$  is a Popov multiplier of the form

$$M(s) = 1 + \eta s \quad \text{with } \eta \in \mathbb{R}. \quad (30)$$

This is a standard and well-known result, although the case with  $\eta < 0$  is often ignored [38,80]. In fact it can be derived as a corollary of the Zames–Falb theorem [9,14].

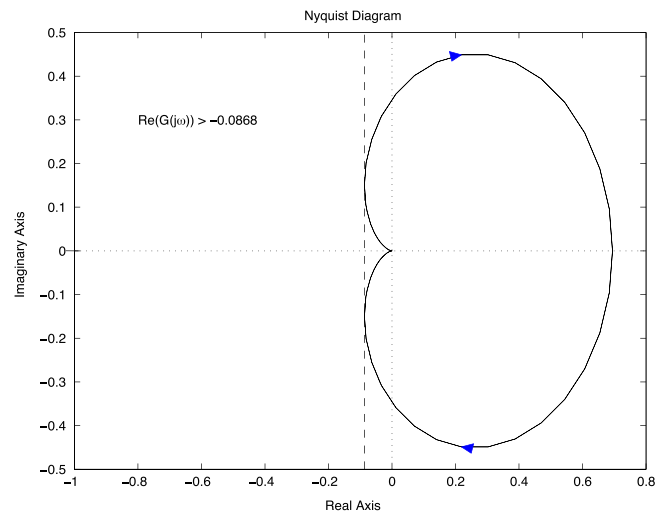

**Fig. 12.** Nyquist plot of  $G$  when  $\zeta = 0.6$ . The plot never encircles the  $-1$  point, so the Nyquist value is infinite. The phase drops from  $+180^\circ$  to  $-180^\circ$ , so  $G$  is not passive. The Nyquist plot of  $G$  is always to the right of  $-0.0868$ , so the Circle Criterion confirms stability for  $k < 1/0.0868$ .

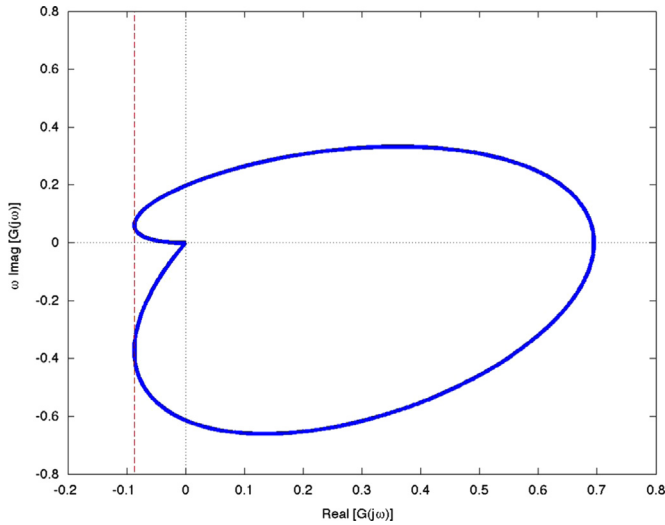

Fig. 13. Popov plot for  $G$  when  $\zeta = 0.6$ .

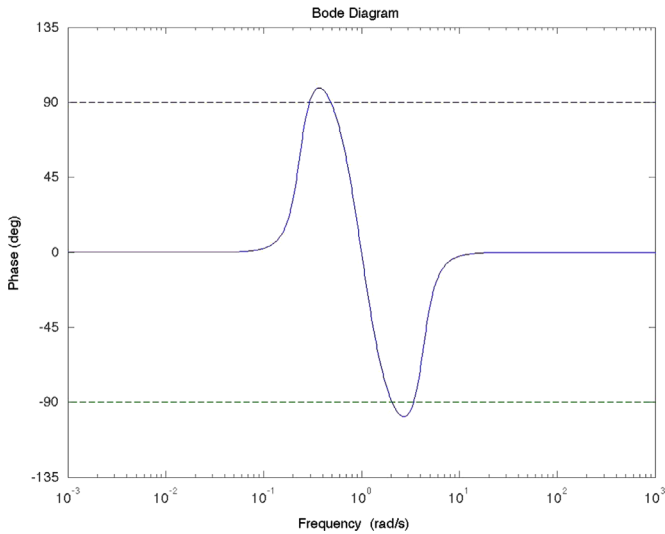

Fig. 14. Phase of  $1 + 15G(j\omega)$ . There are value of  $\omega < 1$  where the phase is greater than  $+90^\circ$  and values of  $\omega > 1$  where the phase is less than  $-90^\circ$ .

One might naïvely expect the Popov Criterion to offer an improvement over the Circle Criterion. However for this example the symmetry of  $G$  ensures this is not the case. The Popov plot in Fig. 13 provides a result no better than the Circle Criterion and shows that the implicit Popov multiplier is  $1 + 0s$ , since the dashed line is vertical. The reason is simple: suppose  $k > 11.52$  (the maximum  $k$  for which the Circle Criterion guarantees stability). There is a frequency interval where the phase of  $1 + kG(j\omega)$  is greater than  $+90^\circ$  and a frequency interval where it is less than  $-90^\circ$ . See Fig. 14 for the case  $k = 15$ . Any Popov multiplier that raises the phase at high frequency (i.e. with positive coefficient) cannot reduce the phase at low frequency. Conversely, any Popov multiplier that reduces the phase at low frequency cannot raise the phase at high frequency. In brief, if  $k > 11.52$  and given some  $\eta \in \mathbb{R}$ , there must exist some frequency  $\omega$  where

$$|\angle\{(1 + \eta j\omega)(1 + kG(j\omega))\}| > 90^\circ.$$

A typical result with  $\eta$  positive is shown in Fig. 15; a negative  $\eta$  would result in a similar but opposite effect.

In the 1960s and 1970s, several other frequency domain conditions based on stability multipliers were tested using graphical interpretations; see [58] as a classical textbook on this topic and

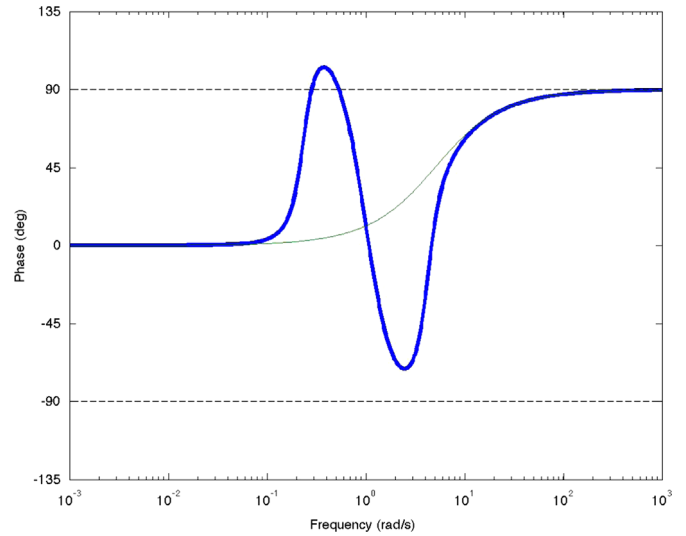

Fig. 15. In blue, phase of  $(1 + 0.2j\omega)(1 + 15G(j\omega))$ . In green, the phase of  $(1 + 0.2j\omega)$ . The multiplier raises the phase at all frequencies. (For interpretation of the references to color in this figure caption, the reader is referred to the web version of this paper.)

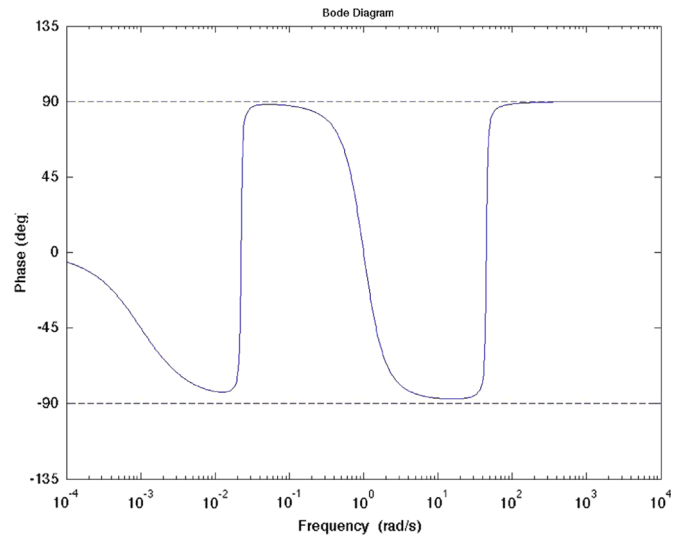

Fig. 16. Phase of  $M(j\omega)(G(j\omega) + 1/k)$  with  $k = 2000$  and  $p = 0.001$ . The phase is always between  $-90^\circ$  and  $+90^\circ$ .

Section 3.4.1 in [7] for a recent overview. In particular, Table 3.1 in [7] can be used to show that the symmetry of the phase prevents other classes of multipliers, such as the Yakubovich multipliers [87], the RL multipliers [9] or the RC multipliers [9], from improving on the Circle Criterion for this example. Similarly the Off-axis Circle Criterion [20] uses either RL or RC multipliers. Note that Park [62] provides a convex search for the Yakubovich multipliers.

#### 4.5. O'Shea's multiplier

O'Shea [60] proposed the multiplier

$$M(s) = \frac{(s+1)(-s+p)}{-s+1}, \quad (31)$$

with  $p > 0$  sufficiently small. This is sufficient to ensure the phase of  $M(G + 1/k)$  lies above  $-90^\circ$  and below  $+90^\circ$  as in see Fig. 16. This in turn is sufficient for stability even though the multiplier has a pole in the right half plane, i.e. the multiplier is noncausal.

In particular, the existence of O'Shea's multiplier  $M$  with the property that  $M(G+1/k)$  has phase on the interval  $(-90^\circ, 90^\circ)$  guarantees the existence of a Zames–Falb multiplier (Definition 3) satisfying the conditions of the Zames–Falb theorem (Theorem 1). Hence the existence of O'Shea's multiplier is sufficient for stability.

The multiplier  $M$  suggested by O'Shea (31) itself is not within the class of Zames–Falb multipliers  $\mathcal{M}$ . We can write

$$\frac{1}{2-p}M(s) = M_{ZF}(s) + \eta s, \quad (32)$$

with

$$M_{ZF}(s) = 1 - \frac{2-2p}{2-p} \frac{1}{-s+1} \quad \text{and} \quad \eta = \frac{1}{2-p}.$$

Since  $M_{ZF} \in \mathcal{M}_a$  we can write  $M$  as the sum of a Zames–Falb multiplier and a Popov term  $\eta s$ . We require a phase-equivalence result [14]: if  $M(G+1/k)$  has phase in  $(-90^\circ, +90^\circ)$  and  $M$  can be written  $M(s) = M_{ZF}(s) + \eta s$  with  $M_{ZF} \in \mathcal{M}$ , then there exists a phase-equivalent  $M_{PE} \in \mathcal{M}$  such that  $M_{PE}(G+1/k)$  has phase in  $(-90^\circ, +90^\circ)$ . In this case, such a  $M_{PE}$  can be constructed as follows. Put  $q = (2-2p)/(2-p)$  and choose  $\rho > 0$  such that  $q < 1-\rho$ , for example  $\rho = p/(4-2p)$ . We can then write

$$\frac{1}{2-p}M(s) = 1 - \frac{q}{-s+1} + \eta s = \left(1 - \rho - \frac{q}{-s+1}\right) + \rho \left(1 + \frac{\eta s}{\rho}\right),$$

Then we can write

$$M_{PE}(s) = \left(1 - \rho - \frac{q}{-s+1}\right) + \rho \left(\frac{1 + \eta s/\rho}{1 + \varepsilon s}\right),$$

for  $\varepsilon > 0$  sufficiently small. The phases of  $M(G+1/k)$  and  $M_{PE}(G+1/k)$  are compared in Fig. 17.

In short, the noncausal multiplier (31) can be used to guarantee the absolute stability of our example for any positive  $k$  provided  $p > 0$  is chosen sufficiently small. A similar analysis guarantees stability for any positive  $k$  provided the damping ratio  $\zeta > 0.5$ . A formal proof requires the concept of phase-equivalence [14,15] which we discuss further in the next section.

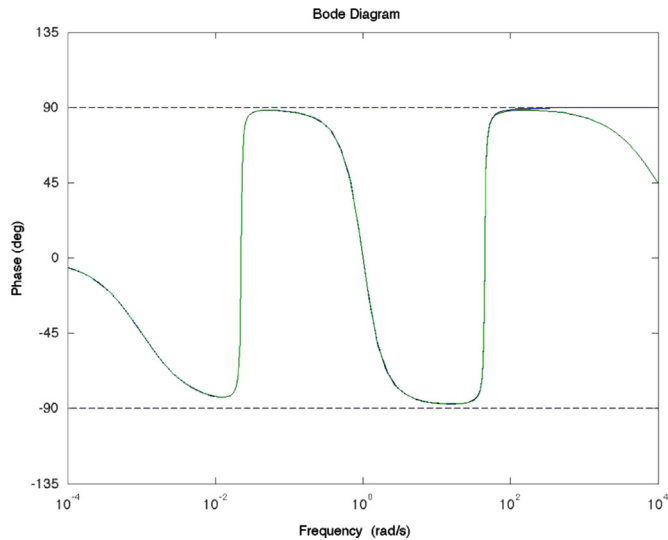

Fig. 17. Phases of  $M(j\omega)(G(j\omega)+1/k)$  and  $M_{PE}(j\omega)(G(j\omega)+1/k)$  where  $M$  is O'Shea's multiplier and  $M_{PE}$  is a phase-equivalent Zames–Falb multiplier. The parameter  $\varepsilon$  is chosen as  $10^{-4}$ . As O'Shea's multiplier includes a Popov term (with positive parameter  $\eta$ ) the corresponding phase tends to  $+90^\circ$  at high frequency, while that for  $M_{PE}$  tends to  $0^\circ$ .

## 5. Further properties

The class of Zames–Falb multiplier is one of the possible classes that have been proposed for analyzing the stability of the Lur'e system (13). The aims of this section are to discuss the phase properties of the Zames–Falb multipliers and the equivalence between different classes of multipliers, where it will be shown that phase is a key factor.

### 5.1. Positivity

One trivial property of the multiplier is that it must be a positive system. By definition, a multiplier is required to preserve the positivity of the class of nonlinearities. As mentioned by Carrasco et al. [13], when a scaled identity is within the class of nonlinearities, then the multiplier itself needs to be positive. Referring to Fig. 8, this can easily be seen because

$$\langle M_a^* \tilde{\phi} \tilde{u}_2, M_c \tilde{u}_2 \rangle = \langle \tilde{\phi} \tilde{u}_2, \underbrace{M_a M_c}_{=M} \tilde{u}_2 \rangle \geq 0,$$

where  $\tilde{u}_2 = u_2 - y_2/k$ . Thus if we consider the particular case  $\tilde{\phi} \tilde{u}_2 = k \tilde{u}_2$  with  $k > 0$ , then

$$\langle \tilde{\phi} \tilde{u}_2, M \tilde{u}_2 \rangle = \langle k \tilde{u}_2, M \tilde{u}_2 \rangle \geq 0,$$

and hence

$$\langle \tilde{u}_2, M \tilde{u}_2 \rangle \geq 0,$$

for all  $\tilde{u}_2 \in \mathcal{L}_2$ .

The phase of the multiplier is required to be within the interval  $[-90^\circ, 90^\circ]$ . However, we cannot consider this as a limitation of the multiplier as the phase of  $(1+kG)$  must belong to the interval  $(-180^\circ, 180^\circ)$  to satisfy the necessity of the Kalman Conjecture.

In the Nyquist diagram, we can find further restrictions on the Nyquist plot of the multiplier  $M \in \mathcal{M}$ . In particular, we can use  $\mathcal{L}_1$  norm properties to ensure that the Nyquist plot belongs to a circle with center  $(1, 0)$  and radius 1 [66]; see Fig. 18. Loosely speaking, it is due to the fact that the  $\mathcal{L}_1$  norm of a system is always greater than its  $\mathbf{H}_\infty$  norm. See [79] for further details.

### 5.2. Noncausal multipliers

Undoubtedly, O'Shea's main contribution to multiplier theory was the introduction of noncausal multipliers (see [22, p. 227]). The motivation was to increase the flexibility of the phase of the multiplier. In this section, we demonstrate this concept. An analytic result can be obtained for rational first order Zames–Falb multipliers.

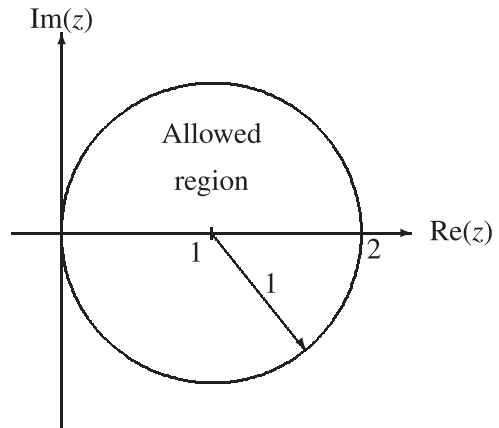

Fig. 18. Allowed region for the Nyquist plot of Zames–Falb multipliers (see further details in [12]).



**Lemma 1.** Given  $\epsilon > 0$ , there exists a first-order causal Zames–Falb multiplier such that its phase is  $90^\circ - \epsilon$  at some frequency. However, if  $M_c$  is a causal rational first-order Zames–Falb multiplier, then  $\angle M_c(j\omega) > -\arcsin(1/3)$  for all  $\omega \in \mathbb{R}$ .

**Lemma 2.** Given  $\epsilon > 0$ , there exists an anticausal first-order Zames–Falb multiplier such that its phase is  $-90^\circ + \epsilon$  at some frequency. However, if  $M_{ac}$  is an anticausal rational first-order Zames–Falb multiplier, then  $\angle M_{ac}(j\omega) < \arcsin(1/3)$  for all  $\omega \in \mathbb{R}$ .

The proofs of these results are straightforward, but they show the significant reduction on the selection of the phase of the multiplier if we limit ourselves solely to causal or anticausal multipliers for a fixed order (see Fig. 19). However, it can be easily shown that a causal multiplier can reach any phase by considering an infinite dimensional multiplier.

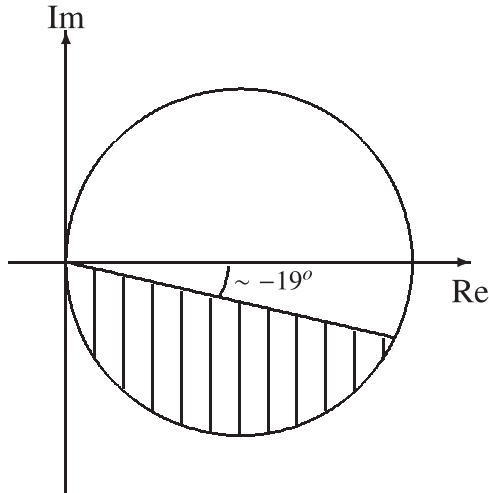

**Fig. 19.** A first-order multiplier cannot reach a phase below  $-19^\circ$ . A symmetric figure can be drawn for anticausal multipliers.

**Lemma 3.** Given  $\theta \in (-90^\circ, 90^\circ)$ , there exist causal or anticausal Zames–Falb multipliers with phase  $\theta$ .

Once again the result is trivial by using the multiplier  $M(s) = 1 + z_1 e^{\pm s}$ . Hence one could be tempted to think that there is no phase limitation if the order is infinite.

### 5.3. Phase limitations of Zames–Falb multipliers

It has been established that the conditions on the Zames–Falb multiplier require some limitation in the selection of the phase.<sup>5</sup> The lack of such limitation would imply that we can make any biproper plant appear passive if its phase is within the interval  $(-180^\circ, 180^\circ)$ ; hence the Kalman conjecture would be true. As the Kalman conjecture is known to be false, the  $\mathcal{L}_1$  condition on the multiplier must have an interpretation as a phase limitation. One such characterization of a limitation is given in [52] (see Fig. 20).

**Lemma 4** (Megretski [52]). Let  $b > a > 0$ ,  $r > b/a$  be real numbers. Let

$$\rho = \rho(a, b, r) = \sup_{t > 0} \frac{|\psi(t)|}{\phi(t)},$$

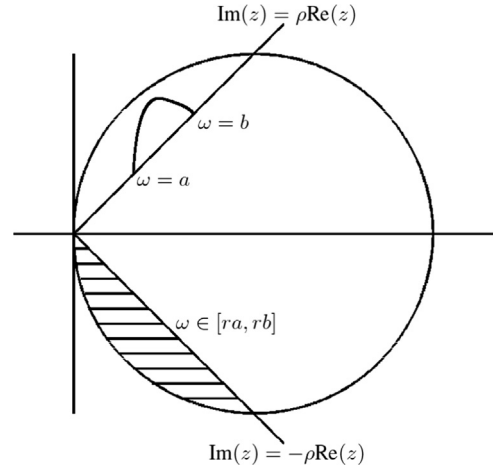

**Fig. 20.** Megretski's phase limitation for Zames–Falb multipliers. If the phase of a multiplier is above  $\tan^{-1}\rho$  for a range of frequencies  $(a, b)$ , then the multiplier cannot reach a phase below  $-\tan^{-1}\rho$  over the range of frequencies  $(ra, rb)$ .

where

$$\psi(t) = -\frac{\cos(rbt)}{rt} + \frac{r \cos(rbt)}{t} - \frac{r \cos(rat)}{t} + \frac{\cos(rat)}{rt},$$

and

$$\phi(t) = (r+1)(b-a) + \frac{r \sin(at)}{t} - \frac{r \sin(bt)}{t} + \frac{\sin(rat)}{rt} + \frac{\sin(rat)}{rt},$$

Then  $\rho < \infty$  and there exist no multiplier  $M(s) \in \mathcal{M}_+$  such that<sup>6</sup>

$$\angle(M(j\omega)) > \tan^{-1}\rho, \omega \in [a, b]$$

and

$$\angle(M(j\omega)) < -\tan^{-1}\rho, \omega \in [a, b]$$

**Remark 2.** A symmetric result, i.e. negative phase at low frequency and positive phase at high frequency, can be straightforwardly developed.

If it has been shown that there is no limitation in the phase of a causal or anticausal multiplier, Megretski's result shows that there is a limitation based on the rate of change of the phase. It can be easily shown with O'Shea's example. Let us consider  $k = \infty$ ; then the required phase properties of the multiplier are presented in Table 1.

As O'Shea [60] mentions, the proposed multiplier ensures stability for any gain for  $\zeta > 0.5$ . For  $\zeta < 0.5$ , the problem remains unsolved, and searches can be tested with this example. However, Fig. 9 shows that no multiplier can ensure stability for large  $k$  when  $\zeta = 0.1$ . So the limiting factor for the phase of multiplier is not the phase itself, but *how fast it changes*. So, for  $\zeta = 0.5$  there exists a multiplier able to change its phase from  $-79^\circ$  up to  $79^\circ$  in two decades; but for  $\zeta = 0.1$ , there is no Zames–Falb multiplier which can change its phase from  $-88^\circ$  up to  $88^\circ$  in two decades, preserving the properties for the rest of frequencies.

The analysis of Megretski [52] is not definitive. It is clear that restrictions to subclasses of Zames–Falb multipliers, such as the causal multipliers, impose further limitations in phase. However no analytic result has yet been provided. Fig. 21 shows the phase of two causal but irrational multipliers. Their phase spans the interval  $(-90^\circ, +90^\circ)$  with very fast transitions from  $-90^\circ$  up to  $+90^\circ$  but slow transitions from  $+90^\circ$  down to  $-90^\circ$ .

<sup>5</sup> For a further discussion on the phase of Zames–Falb multipliers see [27].

<sup>6</sup> The original result is given for all the Zames–Falb multipliers. However, it holds only if  $h(t) \geq 0$  for all  $t$ .

**Table 1**  
Phase properties of a multiplier in order to show that O'Shea example is stable for any slope.

$\zeta$	$-\infty < \omega < 10^{-1}$	$10^{-1} < \omega < 10^1$	$10^1 < \omega < \infty$
0.9	$(-90^\circ, -70^\circ)$	$(-70^\circ, 70^\circ)$	$(70^\circ, 90^\circ)$
0.7	$(-90^\circ, -74^\circ)$	$(-74^\circ, 74^\circ)$	$(74^\circ, 90^\circ)$
0.5	$(-90^\circ, -79^\circ)$	$(-79^\circ, 79^\circ)$	$(79^\circ, 90^\circ)$
0.3	$(-90^\circ, -83^\circ)$	$(-83^\circ, 83^\circ)$	$(83^\circ, 90^\circ)$
0.1	$(-90^\circ, -88^\circ)$	$(-88^\circ, 88^\circ)$	$(88^\circ, 90^\circ)$

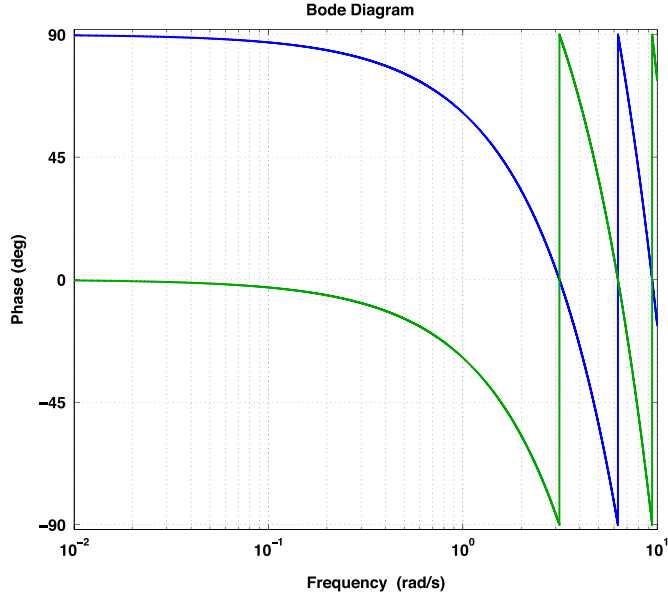

**Fig. 21.** Phase of the multiplier  $1 \pm e^{-s}$ .

#### 5.4. Equivalences

The first equivalence result between classes of multiplier was given by Falb and Zames [24]. In this paper, they show that given any RL and RC multiplier (for definitions, see [24,9]), a Zames–Falb multiplier with the same phase can be found. Then it is no longer important that the class of Zames–Falb multipliers does not include some RL and RC multipliers, since we can always find a “substitute” in the class.

A formal definition is required. However, we need to limit our set of interest. It is a key step in order to be able to establish formal substitution and equivalence results. As we have mentioned, the necessity of the Kalman conjecture is required in order to ensure absolute stability; hence we will restrict our attention to plants where this property is required.

**Definition 5.** The set  $\mathcal{SR}$  is given by the plants  $\tilde{G} = 1 + kG$  with the following properties:

- $1 + kG$  is stable.
- $(1 + \tau kG)^{-1}$  is stable for any  $\tau \in [0, 1]$ .

Loosely speaking, given some plant  $G$  and maximum slope  $k$ , then  $(1 + kG) \notin \mathcal{SR}$ , the existence of a Zames–Falb multiplier such that  $(1 + kG)M$  is positive can be dismissed. Once we have introduced this class of LTI systems, then formal definitions can be given.

**Definition 6 (Phase-substitute).** Let  $M_a$  and  $M_b$  be two multipliers and  $\tilde{G} \in \mathcal{SR}$ . The multiplier  $M_b$  is a phase-substitute of the

multiplier  $M_a$  when

$$\operatorname{Re}\{M_a(j\omega)\tilde{G}(j\omega)\} \geq \delta_1 \quad \forall \omega \in \mathbb{R},$$

for some  $\delta_1 > 0$  implies

$$\operatorname{Re}\{M_b(j\omega)\tilde{G}(j\omega)\} \geq \delta_2 \quad \forall \omega \in \mathbb{R},$$

for some  $\delta_2 > 0$ .

This property has already been used in Section 4.5, and the phase-substitution of multipliers with the addition of the Popov term has been explained. Another simple but insightful equivalence is described as follows:

**Definition 7 (Park's multipliers [62]).** The class of Park's multipliers is defined as follows:

$$M_P(s) = 1 + \frac{bs}{-s^2 + a^2}, \quad (33)$$

for any two scalars  $a$  and  $b$ .

It is straightforward to show that Park's multipliers can be linked with the class developed by Yakubovich [87]. However, a more detailed analysis will show that we can find a Zames–Falb multiplier with the same phase properties.

Firstly, let us find the zeros of a Park multiplier. If  $b > 0$ , then the zeros will be labelled as follows:

$$z_1 = \frac{b - \sqrt{b^2 + 4a^2}}{2},$$

$$z_2 = \frac{b + \sqrt{b^2 + 4a^2}}{2};$$

whereas if  $b < 0$  we will use

$$z_1 = \frac{b + \sqrt{b^2 + 4a^2}}{2},$$

$$z_2 = \frac{b - \sqrt{b^2 + 4a^2}}{2}.$$

This ensures that  $|z_1| < |z_2|$ . Note that  $z_1 z_2 < 0$ .

Secondly, the phase of  $M_P(j\omega)$  is given by the phase of its zeros, since the phase of its poles cancels out, i.e.

$$\angle(M_P(j\omega)) = \angle(j\omega - z_1) + \angle(j\omega - z_2). \quad (34)$$

Finally, the zero with larger absolute value,  $z_2$  can be transformed into a pole reflected in the imaginary axis since  $\angle(j\omega - z_2) = -\angle(j\omega + z_2)$ . As a result, the phase of any Park multiplier is given by

$$\angle(M_P(j\omega)) = \angle(j\omega - z_1) - \angle(j\omega + z_2) = \angle\left(\frac{j\omega - z_1}{j\omega + z_2}\right). \quad (35)$$

So we have found a phase-substitute multiplier that can be rewritten as follows:

$$M(s) = \frac{s - z_1}{s + z_2} = 1 - \frac{z_2 + z_1}{s + z_2}. \quad (36)$$

Then, we can check that  $M \in \mathcal{M}$  since

$$\|m\|_1 = \frac{z_2 + z_1}{z_2} < 1, \quad (37)$$

where  $m$  is the inverse Laplace transform of

$$\frac{z_2 + z_1}{s + z_2}$$

and we have used that  $z_1 z_2 < 0$  and  $|z_1| < |z_2|$ .

This example and the previous example illustrate the concept of phase-substitution. Using this concept, it can be shown that a search over the whole class of Zames–Falb multipliers would be enough to obtain the best possible result compared with any other class of multipliers in the literature [14]. Nevertheless the

significant difficulties in obtaining a convex search over the whole class of Zames–Falb multipliers mean that the parameterizations of other classes of multipliers may still be useful. We discuss searches in the following section.

### 6. Convex searches

Section 4 has illustrated how various stability tests can be used to find the maximum slope of the nonlinearity  $\phi$  for which stability is guaranteed. This, and other sections, have also illustrated how the selection of an appropriate Zames–Falb multiplier can enable more accurate statements regarding the absolute stability of a Lur’e system to be made. Using an example from O’Shea [60] it has been shown that how the selection of such a multiplier may be achieved for a relatively simple system. For more complex systems, it is somewhat more difficult to choose the most “appropriate” Zames–Falb multiplier because the set of such multipliers is extremely large and, in fact, infinite dimensional. Typically, we would like to choose a multiplier which allows us to make the least conservative statements about, for example:

1. the size of slope for which stability is guaranteed;
2. the  $\mathcal{L}_2$  gain from a given input to a given output [71,53].

Choosing such a multiplier which either maximizes the slope size or minimizes the  $\mathcal{L}_2$  gain is not trivial. In this section, several automated searches for rational ( $M \in \mathcal{RM}$ ) multipliers are introduced. The searches described are based on Chen and Wen [18,19], which is similar to that implemented in the IQC toolbox [53,36,21], and also more recent approaches of the authors e.g., [74,16]. The technique of Safonov and Wyetzner [65] and Gapski and Geromel [28], which has recently been updated in [17], is briefly discussed in Section 6.7.

#### 6.1. Linear search in $k$

Modern searches for multipliers are somewhat different to classical graphical criteria (see [58]). In graphical criteria with simple multipliers (e.g. Circle, Popov),  $k_{\max}$  is found directly via a plot of  $G(j\omega)$ , even though an auxiliary multiplier is implicit (see Fig. 13).

The search for more sophisticated multipliers requires a different approach. In this case, a linear search over  $k$  is carried out. Given a value  $k_f$ , then a search over  $\mathcal{M}$  is carried out to find a suitable multiplier for  $\tilde{G} = G + 1/k_f$ , i.e. we search for a multiplier  $M \in \mathcal{M}$  such that

$$\operatorname{Re}\{M(j\omega)(1/k + G(j\omega))\} \geq 0, \tag{38}$$

for all  $\omega > 0$ . If the search is successful, the multiplier found is suitable for any  $k < k_f$ , i.e.

$$\begin{aligned} \operatorname{Re}\{M(j\omega)(1/k + G(j\omega))\} &= \operatorname{Re}\{M(j\omega)/k\} + \operatorname{Re}\{M(j\omega)G(j\omega)\} \\ &\geq \operatorname{Re}\{M(j\omega)/k_f\} + \operatorname{Re}\{M(j\omega)G(j\omega)\} \\ &> 0 \quad \forall \omega \in \mathbb{R}, \end{aligned} \tag{39}$$

where we have used that  $\operatorname{Re}\{M(j\omega)\} > 0$ ; hence we can increase  $k_f$ . If the search is unsuccessful, we reduce  $k_f$  until a successful search is obtained.

Before computational methods were available attempts were made to interpret the Zames–Falb multipliers graphically e.g., [27,48]. It must be highlighted that these geometrical methods also require a linear search. In this tutorial, we focus on the development of convex searches, but Section 3.4.1 of Altshuller [6] provides an overview of such graphical methods (see [5] for an example).

#### 6.2. Time and frequency domain conditions

Recall that the system in Fig. 5 is absolutely stable if there exists a multiplier  $M = 1 - H \in \mathcal{RM}$  which satisfies the following conditions:

1. a frequency domain condition

$$\operatorname{Re}\{M(j\omega)(1 + kG(j\omega))\} \geq 0 \quad \forall \omega \in \mathbb{R}; \tag{40}$$

2. a time domain condition

$$\|h\|_1 \leq 1. \tag{41}$$

A central issue, which will recur throughout this section, is that of combining, in an efficient and tractable manner, these two conditions. In particular, it is generally difficult to provide a frequency domain characterization of the  $\mathcal{L}_1$  norm, although, as discussed in Section 5, the  $\mathcal{L}_1$  norm requirement appears to place a limit on the rate-of-change of phase of the multiplier [52].

A result which we shall invoke several times in this section is the so-called *Positive Real Lemma* given below. This can be interpreted as a special case of the KYP lemma [63].

**Lemma 5** (Rantzer [63]). *Let  $G(s)$  be a transfer function with Rosenbrock matrix (17) such that  $\det(j\omega I - A) \neq 0$  for all  $\omega \in \mathbb{R}$ .*

1.  $G(j\omega)^* + G(j\omega) \geq 0 \quad \forall \omega \in \mathbb{R}$ ,

if and only if  $(A, B)$  is controllable and there exists a  $P = P'$  such that

$$\begin{bmatrix} A'P + PA & PB - C' \\ \star & -D - D' \end{bmatrix} \leq 0.$$

2.  $G(j\omega)^* + G(j\omega) > 0 \quad \forall \omega \in \mathbb{R}$ ,

if and only if there exists a  $P = P'$  such that

$$\begin{bmatrix} A'P + PA & PB - C' \\ \star & -D - D' \end{bmatrix} < 0.$$

The Positive Real Lemma provides a connection between positive realness in the frequency domain and a matrix inequality. It is of central importance in casting conditions involving Zames–Falb multipliers as LMI's.

#### 6.3. Preliminary manipulations

The main goal of this section is to translate the positive real condition (40) and the  $\mathcal{L}_1$  condition (41) into tractable, automated searches. Two approaches to this will be described, but both ways share some initial manipulation which will be covered here. Assume first that  $H(s)$  has state-space realization

$$H(s) \sim \begin{bmatrix} \tilde{A}_H & \tilde{B}_H \\ \tilde{C}_H & \tilde{D}_H \end{bmatrix}, \tag{42}$$

where the matrices  $\tilde{\mathbf{A}}_H, \tilde{\mathbf{B}}_H, \tilde{\mathbf{C}}_H, \tilde{\mathbf{D}}_H$  are to be determined.<sup>7</sup> Here and elsewhere  $G$  has the following state-space realization:

$$G(s) \sim \begin{bmatrix} A_p & B_p \\ C_p & D_p \end{bmatrix}. \quad (43)$$

Given these two state-space realizations, it then follows that

$$M(j\omega)(kG(j\omega)+1) \sim \begin{bmatrix} A_I & B_I \\ C_I & D_I \end{bmatrix}, \quad (44)$$

where

$$\begin{bmatrix} A_I & B_I \\ C_I & D_I \end{bmatrix} = \begin{bmatrix} A_p & 0 & B_p \\ -\tilde{\mathbf{B}}_H k C_p & \tilde{\mathbf{A}}_H & \tilde{\mathbf{B}}_H(I - kD_p) \\ k(I - \tilde{\mathbf{D}}_H)C_p & \tilde{\mathbf{C}}_H & (I - \tilde{\mathbf{D}}_H)(I - kD_p) \end{bmatrix}. \quad (45)$$

Our objective then becomes a search, over the multiplier state-space matrices  $\tilde{\mathbf{A}}_H, \tilde{\mathbf{B}}_H, \tilde{\mathbf{C}}_H, \tilde{\mathbf{D}}_H$ , in order to maximize the scalar  $k$  which represents the slope restriction of our nonlinearity. Invoking Lemma 5 now shows that the positive real condition (40) can, equivalently, be expressed as a search over real symmetric matrices  $\mathbf{P}$  such that the following matrix inequality is satisfied

$$\begin{bmatrix} A_I \mathbf{P} + \mathbf{P} A_I & \mathbf{P} B_I - C_I' \\ \star & -D_I - D_I' \end{bmatrix} < 0. \quad (46)$$

Using the realization (45), this inequality can be written as

$$\begin{bmatrix} \begin{bmatrix} -\tilde{\mathbf{B}}_H k C_p & \tilde{\mathbf{A}}_H \end{bmatrix} \mathbf{P} + \mathbf{P} \begin{bmatrix} -\tilde{\mathbf{B}}_H k C_p & \tilde{\mathbf{A}}_H \end{bmatrix} & \mathbf{P} \begin{bmatrix} B_p \\ \tilde{\mathbf{B}}_H(I - kD_p) \end{bmatrix} - \begin{bmatrix} k C_p'(I - \tilde{\mathbf{D}}_H) \\ \tilde{\mathbf{C}}_H' \end{bmatrix} \\ \star & -(I - \tilde{\mathbf{D}}_H)(I - kD_p) - (I - kD_p)(I - \tilde{\mathbf{D}}_H) \end{bmatrix} < 0. \quad (47)$$

Note that because the matrices  $(A_I, B_I, C_I, D_I)$  are affine functions of multiplier matrices  $\tilde{\mathbf{A}}_H, \tilde{\mathbf{B}}_H, \tilde{\mathbf{C}}_H, \tilde{\mathbf{D}}_H$  this matrix inequality is nonlinear, due to products of  $\tilde{\mathbf{A}}_H, \tilde{\mathbf{B}}_H$  and  $\mathbf{P}$ , and therefore not amenable to efficient solution. While this section does not seem to have eased the difficulty of the search for Zames–Falb multipliers, it transpires that the inequality (47) is a useful stepping stone towards a convex search. The following two sections will show two different approaches for simplifying this inequality and imposing the  $\mathcal{L}_1$  bounds (41).

#### 6.4. Structured multipliers

The problems with searches for multipliers as they stand are two-fold: the troublesome  $\mathcal{L}_1$  condition (41) and the nonlinear matrix inequality (47) that arises as a result of the positive real condition (40). The approach advocated by [18,19] (see also [32,53]) is to structure the multipliers in such a way that (i)  $\mathcal{L}_1$  norm bounds may easily be obtained and (ii) the nonlinear matrix inequality (47) becomes a linear matrix inequality. The approach described here follows [18]. The first observation to make is that if a transfer function,  $H(s)$ , is given a first order structure, it is easy to calculate its  $\mathcal{L}_1$  norm as illustrated below.

**Example 1** (A first order multiplier). Let

$$H(s) = \frac{\kappa}{s+a}; \quad \text{then } \|h\|_1 = \frac{\kappa}{a}.$$

Thus the  $\mathcal{L}_1$  bound is simply  $\kappa/a < 1$ . For fixed  $a$  this is simply a linear inequality in  $\kappa$  and the associated state-space matrices are

$$A_H = -a \quad B_H = 1 \quad \tilde{\mathbf{C}}_H = \kappa \quad D_H = 0.$$

<sup>7</sup> Color highlights when these matrices are considered as variables, other variables within LMI's are typed in bold.

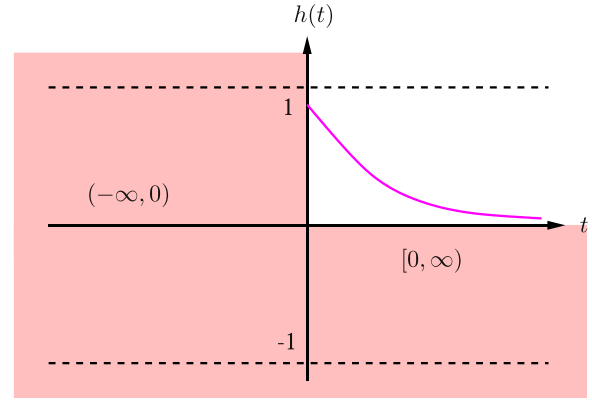

Fig. 22. A causal multiplier with positive impulse response.

Notice that, under the assumption that  $a$  is constant, three of the four state-space matrices are constant, which means that inequality (47) is actually linear. Therefore, with this structure of multiplier we have obtained a linear inequality for the  $\mathcal{L}_1$  norm and a linear matrix inequality for the positive real condition: a tractable search.

The basic approach by [18] is to extrapolate from the above example. By restricting attention to a sub-class of Zames–Falb multipliers, the  $\mathcal{L}_1$  norm conditions become simple linear inequalities. Also, because this ensures that matrices  $A_H$  and  $B_H$  are constant, the nonlinear matrix inequality (47) becomes linear.

##### 6.4.1. A class of causal positive multipliers

In order to describe the work of [18] concisely, we first consider the following sub-class of Zames–Falb multipliers:

$$\mathcal{R}\mathcal{M}_{+c} = \{M(s) = 1 - H_{+c}(s)\} \quad (48)$$

where  $h_{+c}(t) = \mathcal{L}^{-1}\{H_{+c}(s)\}$  is such that  $h_{+c}(t) = 0 \quad \forall t < 0$  and  $h_{+c}(t) \geq 0 \quad \forall t \geq 0$ . In other words, the multiplier is assumed causal and the impulse response  $h_{+c}(t)$  is positive. An example of such a function is shown in Fig. 22. These assumptions will be relaxed in subsequent sections.

This representation of the multiplier has several advantages: firstly it significantly reduces the complexity of the  $\mathcal{L}_1$  inequality, viz:

$$\begin{aligned} \|h\|_1 &= \int_{-\infty}^{\infty} |h_{+c}(t)| dt \\ &= \int_0^{\infty} |h_{+c}(t)| dt \quad (\text{causality}) \\ &= \int_0^{\infty} h_{+c}(t) dt \quad (\text{positivity}) \\ &< 1. \end{aligned}$$

In this case, the following theorem can be used for approximating such functions:

**Theorem 2** (On approximation in  $\mathcal{L}_1[0, \infty)$ , Szegő [69]). For any  $h(t) \geq 0 \in \mathcal{L}_1[0, \infty)$  and any  $\epsilon > 0$  there exists  $\kappa_i^{+c}$  and  $N$  such that

$$\int_0^{\infty} \left| h(t) - \sum_{i=0}^N \kappa_i^{+c} e^{-t} \right| dt < \epsilon.$$

The implications of this are the following: by choosing  $N$  large enough,  $h_{+c}(t)$  can be arbitrarily well approximated by a sum of orthogonal functions. This means that, for  $h_{+c}(t)$ , we can always find a phase equivalent multiplier represented by a sum of first order functions. In addition, with this approximation, the  $\mathcal{L}_1$  norm can be calculated explicitly and the  $\mathcal{L}_1$  constraints are linear

inequalities in  $\kappa_i^{+c}$ :

$$\|h_{+c}\|_1 = \sum_{i=0}^N (\kappa_i^{+c})! \Rightarrow \sum_{i=0}^N (\kappa_i^{+c})! < 1. \quad (49)$$

The above follows from considering the Laplace Transform of  $e^{-t}$  for  $i \in \{0, 1, \dots, N\}$ , i.e.

$$H_{+c}(s) = \sum_{i=0}^N \frac{\kappa_i^{+c}}{(s+1)^{i+1}} \sim \left[ \begin{array}{c|c} A_H & B_H \\ \hline \tilde{C}_H & 0 \end{array} \right] \quad (50)$$

The main issue in the application of this result is the requirement that  $h_{+c}(t) \geq 0$  for all  $t \geq 0$ . To guarantee this, note that  $h_{+c}(t)$  is given by

$$h_{+c}(t) = \sum_{i=0}^N \kappa_i^{+c} e^{-t} t^i \quad (51)$$

for some  $N$  and for some  $\kappa_i^{+c}$  to be chosen. Then  $h_{+c}(t) \geq 0$  for all  $t \geq 0$  if

$$\sum_{i=0}^N \kappa_i^{+c} t^i \geq 0 \quad \forall t \geq 0. \quad (52)$$

Chen and Wen [19] have shown that this time-domain condition is equivalent to

$$\underbrace{\sum_{i=0}^N \kappa_i^{+c} (-1)^i s^{2i}}_{S_{+c}(s)} \geq 0 \quad \forall s = j\omega. \quad (53)$$

A state-space realization of  $S_{+c}(s)$  can then be given as

$$S_{+c}(s) \sim \left[ \begin{array}{c|c} A_{+c} & B_{+c} \\ \hline C_{+c} & D_{+c} \end{array} \right], \quad (54)$$

where the structure of the above state-space matrices is given by [19]. In particular  $C_{+c}$  and  $D_{+c}$  are structured affine functions of the  $\kappa_i^{+c}$ . Then applying Lemma 5 to inequality (54) we obtain the matrix inequality

$$\left[ \begin{array}{c|c} A'_{+c} X_{+c} + X_{+c} A_{+c} & X_{+c} B_{+c} + C_{+c} \\ \hline \star & D_{+c} + D'_{+c} \end{array} \right] \leq 0, \quad (55)$$

for some  $X_{+c} = X'_{+c}$ . Noting that  $A_{+c}$  and  $B_{+c}$  are constant, and that  $C_{+c}(\kappa_i^{+c})$  and  $D_{+c}(\kappa_i^{+c})$  are affine functions of  $\kappa_i^{+c}$ , we have an LMI in  $X_{+c}$ , and structured  $C_{+c}(\kappa_i^{+c})$  and  $D_{+c}(\kappa_i^{+c})$ . Thus letting  $H(s) = H_{+c}(s)$ , inequality (47) can be expressed as the following

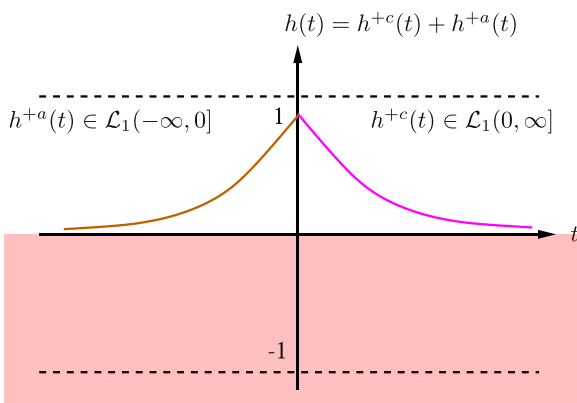

Fig. 23. A noncausal multiplier with positive impulse response.

inequality.

$$\left[ \begin{array}{c|c} A_p & 0 \\ \hline -B_H k C_p & A_H \end{array} \right] \mathbf{P} + \mathbf{P} \left[ \begin{array}{c|c} A_p & 0 \\ \hline B_H k C_p & A_H \end{array} \right] \mathbf{P} \left[ \begin{array}{c} B_p \\ B_H(I - kD_p) \end{array} \right] - \left[ \begin{array}{c} kC'_p \\ \tilde{C}_H \end{array} \right] < 0 \quad (56)$$

For a fixed  $k$ , inequality equations (54), (56) and (51) form a system of linear matrix inequalities. Thus, in this case, the search for a multiplier becomes an LMI problem.

#### 6.4.2. Noncausal multipliers

A restriction in the results derived so far is that we have assumed the multiplier,  $M(s)$  is causal, that is  $h(t) = 0 \quad \forall t < 0$ . As explained earlier in the paper, this may cause some conservatism. However, this assumption can be removed relatively easily by structuring  $h(t)$  as the sum of a causal part and an anticausal part, viz,

$$h(t) = h_{+c}(t) + h_{+a}(t) \quad (57)$$

where  $h_{+c} \in \mathcal{L}_1[0, \infty)$  and  $h_{+a} \in \mathcal{L}_1(-\infty, 0]$ . An example of such an  $h(t)$  is shown in Fig. 23. A similar approximation to that given in Theorem 2 can then be used to approximate the anti-causal part of  $h(t)$  as

$$h_{+a}(t) \approx \sum_{i=0}^N \kappa_i^{+a} e^{t} t^i, \quad (58)$$

which is again a sum of orthogonal terms. Recalling the approximation (52) for the causal part of  $h_{+c}(t)$ , the  $\mathcal{L}_1$  constraint (41) can again be replaced by the linear inequality

$$\|h\|_1 = \sum_{i=0}^N (\kappa_i^{+c} + (-1)^i \kappa_i^{+a})! < 1, \quad (59)$$

which is a linear inequality in  $\kappa_i^{+c}$  and  $\kappa_i^{+a}$ . In the same way as before if we assign

$$S_{+a}(s) \sim \left[ \begin{array}{c|c} A_{+a} & B_{+a} \\ \hline C_{+a} & D_{+a} \end{array} \right], \quad (60)$$

where  $A_{+a}$  and  $B_{+a}$  are constant, and  $C_{+a}(\kappa_i^{+a})$  and  $D_{+a}(\kappa_i^{+a})$  are affine functions of  $\kappa_i^{+a}$ . Then following a similar line of reasoning to that in Eqs. (53)–(54), it follows that  $h_{+a}(t) \geq 0$  providing there exists a symmetric matrix  $X_{+a}$  satisfying the LMI:

$$\left[ \begin{array}{c|c} A'_{+a} X_{+a} + X_{+a} A_{+a} & X_{+a} B_{+a} + C_{+a} \\ \hline \star & D_{+a} + D'_{+a} \end{array} \right] \leq 0,$$

In this case, a state-space realization for  $H(s)$  is given by

$$H(s) = \sum_{i=0}^N \left( \frac{\kappa_i^{+c}}{(s+1)^{i+1}} - \frac{\kappa_i^{+a}}{(s-1)^{i+1}} \right) \sim \left[ \begin{array}{c|c} A_H & B_H \\ \hline \tilde{C}_H & 0 \end{array} \right].$$

This realization can then be used to obtain an LMI from (47).

#### 6.4.3. Non-positive multipliers

Previously it was assumed that  $h(t) = h_{+c}(t) \geq 0 \quad \forall t$ . This assumption can be relaxed by assuming  $h(t)$  is the difference between two positive impulse responses

$$h(t) = h_{+c}(t) - h_{-c}(t) \quad h_{+c}(t), h_{-c}(t) \geq 0 \quad \forall t \quad (61)$$

From this it follows that a bound on the  $\mathcal{L}_1$  norm is given by

$$\|h\|_1 \leq \|h_{+c}\|_1 + \|h_{-c}\|_1. \quad (62)$$

Because both  $h_{+c}(t)$  and  $h_{-c}(t)$  are assumed positive for all  $t$ , arguments mirroring those in the two above subsections can be used to derive LMI conditions for both the strict positive real condition (47) and the guarantees of positivity. The  $\mathcal{L}_1$  constraint

can again be simplified to the inequality

$$\sum_{i=0}^N (\kappa_i^{+c} + (-1)^i \kappa_i^{+a} + \kappa_i^{-c} + (-1)^i \kappa_i^{-a}) i! < 1, \quad (63)$$

which is linear in  $\kappa_i^{+c}$ ,  $\kappa_i^{+a}$ ,  $\kappa_i^{-c}$  and  $\kappa_i^{-a}$ : we have a system of LMI's as before.

#### 6.4.4. Remarks on the structured approach

There are two main criticisms which could be levelled at the fixed structure approach.

*Complexity/conservatism of approximation:* In common with all Zames–Falb multiplier searches, the approach of [18] searches over only a subset of these multipliers, namely over the set

$$\mathcal{RM}_N = \left\{ M(s) = 1 - H(s) : h(t) = \sum_{i=0}^N \kappa_i^{+c} e^{-t^i} + \kappa_i^{+a} e^{t^i} + \kappa_i^{-c} e^{-t^i} + \kappa_i^{-a} e^{t^i} \right\} \subset \mathcal{RM}. \quad (64)$$

The order of the multiplier is proportional to  $4N$  in this case, where  $N$  is a free parameter indicating the accuracy of the approximation: large  $N$  will imply that  $\mathcal{RM}_N$  is in some sense a denser approximation of  $\mathcal{RM}$ , but large  $N$  implies a large computational burden as the larger number of states imply numerous LMI variables. In short: there is a clear trade-off between conservatism and computational efficiency, and the choice of the integer  $N$  may be problem-dependent. In particular, as  $N$  increases, the problem becomes ill-conditioned.

*The decomposition  $h(t) = h^+(t) - h^-(t)$ :* Although this decomposition is not conservative when  $N$  approaches infinity (see [78]), for finite values of  $N$  it may introduce some conservatism, since a triangular inequality is used to bound the  $\mathcal{L}_1$ -norm. This is confirmed by numerical results [15]. In particular, if  $h(t)$  changes sign (see Fig. 24) a nonsmooth function must be approximated with smooth functions, which is only possible if  $N$  approaches infinity. As previously mentioned, the problem becomes ill-conditioned as  $N$  increases; hence this decomposition may be conservative in practice.

#### 6.5. Plant-order multipliers

An issue with the structured multipliers introduced in the foregoing section is that the conservatism is heavily dependent on the choice of  $N$  which determines the order of the multiplier. Indeed, for certain choices of multiplier a very large  $N$  would need to be chosen in order to reduce the conservatism to acceptable levels. In addition, although there is a clear trade-off between computational requirements and conservatism, the choice of  $N$  for a particular problem is by no means obvious.

For this reason, in a series of papers [74,75,71,12,76,16] the authors have developed an alternative method for searching for multipliers based on a change of variables similar to that used in  $\mathbf{H}_\infty$  controller design [67]. The main idea is that, if the multiplier is unstructured, but

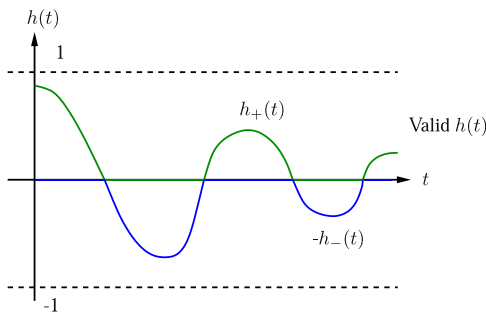

Fig. 24. Smooth  $h(t)$  difficult to decompose as smooth  $h_+(t)$  and  $h_-(t)$ .

its order is the same as the plant, then a change of variables may be used to “linearize” some of the resulting matrix inequalities. The approach also uses a pseudo-LMI approach in order to bound the  $\mathcal{L}_1$  norm of the transfer function  $H(s)$ ; the approach is conservative but it can be easily accommodated in the plant-order approach. The restriction of attention to plant order multipliers,  $\mathcal{RM}_{p0} \subset \mathcal{RM}$  obviously introduces some conservatism *a priori* but the resulting search procedure is, with a slight caveat, entirely systematic.

#### 6.5.1. Causal plant order multipliers

In this section we restrict ourselves to causal plant order multipliers

$$\mathcal{RM}_{p0} = \{M(s) = 1 - H(s) : H(s) \in \mathbf{RH}_\infty\}, \quad (65)$$

and where  $\deg(H(s)) = \deg(G(s)) = n_p$ . The assumption that  $H \in \mathbf{RH}_\infty$  implies that the matrix  $A_H$  is Hurwitz, but no structure is imposed. This absence of structure in the multiplier is required for the change of variables proposed later, but it also means that calculating  $\|h\|_1$  accurately is generally difficult. Instead, a convenient upper bound from the literature will be used.

**Theorem 3** (Scherer et al. [67] and Abedor et al. [1]). *Let  $H \in \mathbf{RH}_\infty$ . Then*

$$\|h\|_1 \leq \xi \quad \text{if} \quad \exists \mathbf{Y} = \mathbf{Y}' > 0, \quad \mu > 0, \quad \lambda > 0 \quad \text{s.t.}$$

$$\begin{bmatrix} \tilde{\mathbf{A}}_H' \mathbf{Y} + \mathbf{Y} \tilde{\mathbf{A}}_H + \lambda \mathbf{Y} & \mathbf{Y} \tilde{\mathbf{B}}_H \\ \star & -\mu \mathbf{I} \end{bmatrix} < 0, \quad (66)$$

$$\begin{bmatrix} -\lambda \mathbf{Y} & 0 & \tilde{\mathbf{C}}_H' \\ \star & (\xi - \mu) \mathbf{I} & \tilde{\mathbf{D}}_H' \\ \star & \star & \xi \mathbf{I} \end{bmatrix} \geq 0. \quad (67)$$

It is emphasized that Theorem 3 gives only an upper bound on the  $\mathcal{L}_1$  norm,  $\|h\|_1 \leq \xi$ ; it may be extremely conservative. Another issue with Theorem 3 is that the two matrix inequalities are “not quite” LMIs due to the presence of the free scalar  $\lambda > 0$ . The consequence of this is that the plant order searches proposed here will take the form of LMI's plus a line search, which is computationally cumbersome compared to an LMI, but relatively easy – and entirely systematic – to implement.

The first step in obtaining convenient plant-order multiplier searches is the partitioning of the matrix  $\mathbf{P} = \mathbf{P}'$  in the positive real condition (47). It is assumed that  $\mathbf{P} > 0$  and therefore that its inverse  $\mathbf{Q}^{-1} = \mathbf{P}$  exists. This allows one to write

$$\begin{bmatrix} \mathbf{Q}_{11} & \mathbf{Q}_{12} \\ \mathbf{Q}_{12} & \mathbf{Q}_{22} \end{bmatrix} \begin{bmatrix} \mathbf{P}_{11} & \mathbf{P}_{12} \\ \mathbf{P}_{12} & \mathbf{P}_{22} \end{bmatrix} = \begin{bmatrix} \mathbf{I} & 0 \\ 0 & \mathbf{I} \end{bmatrix}, \quad (68)$$

where each of the sub-matrices,  $\mathbf{P}_{ij}, \mathbf{Q}_{ij} \in \mathbb{R}^{n \times n}$ . Based on this partitioning, the following matrices are defined:

$$\mathbf{\Pi}_1 := \begin{bmatrix} \mathbf{Q}_{11} & \mathbf{I} \\ \mathbf{Q}_{12} & 0 \end{bmatrix}, \quad \mathbf{\Pi}_2 := \begin{bmatrix} \mathbf{I} & 0 \\ \mathbf{P}_{11} & \mathbf{P}_{12} \end{bmatrix}. \quad (69)$$

Using the congruence transformation  $\text{diag}(\mathbf{\Pi}_1, \mathbf{I})$  and noting that  $\mathbf{\Pi}_1 \mathbf{P} = \mathbf{\Pi}_2$ , the positive real condition (47) is equivalent to

$$\begin{bmatrix} \mathbf{\Pi}_1' \mathbf{A}_1 \mathbf{\Pi}_2' + \mathbf{\Pi}_2 \mathbf{A}_1 \mathbf{\Pi}_1 & \mathbf{\Pi}_2 \mathbf{B}_1 - \mathbf{\Pi}_1' \mathbf{C}_1 \\ \star & -\mathbf{D}_1 - \mathbf{D}_1' \end{bmatrix} < 0. \quad (70)$$

After some algebra, it can be deduced that this inequality is equivalent to

$$\begin{bmatrix} \mathbf{S}_{11} \mathbf{A}_p + \mathbf{A}_p' \mathbf{S}_{11} & \mathbf{S}_{11} \mathbf{A}_p + \mathbf{A}_p' \mathbf{P}_{11} + k \mathbf{C}_p' \mathbf{B}_H + \mathbf{A}_H' & \mathbf{S}_{11} \mathbf{B}_p + \mathbf{C}_H - k \mathbf{C}_p' (1 - \mathbf{D}_H) \\ \star & \mathbf{P}_{11} \mathbf{A}_p + \mathbf{A}_p' \mathbf{P}_{11} + k (\mathbf{B}_H + \mathbf{C}_p' \mathbf{B}_H) & \mathbf{P}_{11} \mathbf{B}_p + \mathbf{B}_H (k \mathbf{D}_p + 1) - k \mathbf{C}_p' (1 - \mathbf{D}_H)' \\ \star & \star & -(k \mathbf{D}_p + 1) (1 - \mathbf{D}_H) (1 - \mathbf{D}_H)' (k \mathbf{D}_p + 1) \end{bmatrix} < 0 \quad (71)$$

which is an LMI in  $\mathbf{P}_{11}, \mathbf{S}_{11} > 0, \mathbf{A}_H, \mathbf{B}_H, \mathbf{C}_H, \mathbf{D}_H$  for fixed  $k$ , where  $\mathbf{S}_{11} = \mathbf{Q}_{11}^{-1}$  and

$$\mathbf{A}_H := \mathbf{P}_{12} \tilde{\mathbf{A}}_H \mathbf{Q}'_{12} \mathbf{S}_{11}, \quad (72)$$

$$\mathbf{B}_H := \mathbf{P}_{12} \tilde{\mathbf{B}}_H, \quad (73)$$

$$\mathbf{C}_H := \tilde{\mathbf{C}}_H \mathbf{Q}'_{12} \mathbf{S}_{11}, \quad (74)$$

$$\mathbf{D}_H := \tilde{\mathbf{D}}_H. \quad (75)$$

A similar congruence transformation can be applied to the  $\mathcal{L}_1$  inequality equations (66) and (67) in order to arrive at expressions in the new coordinates  $(\mathbf{A}_H, \mathbf{B}_H, \mathbf{C}_H, \mathbf{D}_H)$ . In order for this to work, the choice  $\mathbf{Y} = \mathbf{P}_{22}$  in inequality equations (66) and (67) is made. With this choice, the congruence transformation  $\text{diag}(\mathbf{Q}_{12}, I)$  is applied to inequality (66) and the congruence transformation  $\text{diag}(\mathbf{Q}_{11}^{-1} \mathbf{Q}_{12}, I, I)$  is made to inequality (67). Under these congruence transformations, inequality equations (66) and (67) then become equivalent to

$$\begin{bmatrix} -\mathbf{A}_H - \mathbf{A}'_H + \lambda(\mathbf{P}_{11} - \mathbf{S}_{11}) & \mathbf{B}_H \\ \star & -\mu \end{bmatrix} < 0, \quad (76)$$

$$\begin{bmatrix} \lambda(\mathbf{P}_{11} - \mathbf{S}_{11}) & 0 & \mathbf{C}'_H \\ \star & 1 - \mu & \mathbf{D}'_H \\ \star & \star & 1 \end{bmatrix} > 0. \quad (77)$$

Together, for fixed  $k$ , inequalities equations (71), (76) and (77) form a system of linear matrix inequalities plus a line search over  $\lambda > 0$ . This problem can be solved relatively easily using modern software and the multiplier can be recovered by using Eqs. (72)–(75).

### 6.5.2. Anticausal multipliers

A key restriction so far is that  $M(s)(H(s))$  is assumed causal. Similar results but with  $M(s)$  assumed anticausal can be obtained with the aid of the following result.

**Theorem 4** (Carrasco et al. [16]). *Let  $H \in \mathbf{RH}_{\infty}^-$ . Then*

$$\|h\|_1 \leq \xi \quad \text{if} \quad \exists \mathbf{Y} = \mathbf{Y}' < 0, \quad \mu > 0, \quad \lambda > 0 \quad \text{s.t.}$$

$$\begin{bmatrix} \tilde{\mathbf{A}}_H' \mathbf{Y} - \mathbf{Y} \tilde{\mathbf{A}}_H + \lambda \mathbf{Y} & \mathbf{Y} \tilde{\mathbf{B}}_H \\ \star & -\mu I \end{bmatrix} < 0, \quad (78)$$

$$\begin{bmatrix} \lambda \mathbf{Y} & 0 & \tilde{\mathbf{C}}_H' \\ \star & (\xi - \mu)I & \tilde{\mathbf{D}}_H' \\ \star & \star & \xi I \end{bmatrix} \geq 0. \quad (79)$$

The consequence of  $\mathbf{Y} < 0$  is that when applying the KYP (Lemma 5), for nonsingularity of  $\mathbf{P}$  to be guaranteed (as we need to use  $\mathbf{Q} = \mathbf{P}^{-1}$ ), instead of stipulating  $\mathbf{P} > 0$ , instead it is stipulated that  $\mathbf{P} < 0$ . Using a similar reasoning to before, it then follows that the positive real condition is satisfied if the matrix inequality (71) is satisfied. Similarly, invoking Theorem 4 and applying similar reasoning to the causal case, the  $\mathcal{L}_1$  inequalities become the following:

$$\begin{bmatrix} -\mathbf{A}_H - \mathbf{A}'_H - \lambda(\mathbf{P}_{11} - \mathbf{S}_{11}) & \mathbf{B}_H \\ \star & -\mu \end{bmatrix} < 0, \quad (80)$$

$$\begin{bmatrix} -\lambda(\mathbf{P}_{11} - \mathbf{S}_{11}) & 0 & \mathbf{C}'_H \\ \star & 1 - \mu & \mathbf{D}'_H \\ \star & \star & 1 \end{bmatrix} \geq 0. \quad (81)$$

Together inequality equations (71), (80) and (81) form a system of LMI's plus a line search over  $\lambda > 0$ . This set of LMI's is similar to the

causal result given earlier but, since it results in the return of anticausal multipliers can sometimes yield much less conservative results.

### 6.5.3. Including Popov multipliers

Popov multipliers are not bounded on the imaginary axis and so, strictly speaking, do not belong to the class of Zames–Falb multipliers. However, following arguments given in Section 4 (see [14]), they can be considered as anticausal relaxations in the case of causal Zames–Falb multipliers; or, as causal relaxations in the case of anticausal multipliers. Space prohibits a full discussion, but it suffices to say that they are useful in the plant-order searches proposed earlier (see [71,76]).

### 6.5.4. Remarks on the plant-order approach

The plant order approach is a systematic search for Zames–Falb multipliers, but the nature of the approach is inherently restrictive: the order is fixed *a priori*, the manner of including the  $\mathcal{L}_1$  constraint has several sources of conservatism and, excluding the Popov terms, the multiplier returned is either causal or anticausal. A common criticism of multiplier techniques is the poor scaling of dynamic multiplier searches with problem complexity. The plant order approach described here also suffers from that due to the inclusion of the line search over  $\lambda$ , and, to a lesser extent, due to the full-block nature of the matrix variables in the LMIs. Another subtle issue with the plant order approach is that, as described here, it is only applicable to the case of  $\phi$  being *odd*. This is not the case with the structured approach of [19] or the approach using irrational multipliers [17].

### 6.6. Application of search techniques to O'Shea's example

This section illustrates the application of the search techniques described to O'Shea's example. The Zames–Falb searches are compared to the well-known Circle Criterion, Park's Criterion [62] and also the non-rational Zames–Falb searches of [17], which have not been described in detail in the paper. The Zames–Falb searches used are the causal [74] and anticausal plant-order searches [16] described in Section 6.5, these same searches with the addition of Popov multipliers [71,76,16], and the structured searches of [18] from Section 6.4. The plant-order searches were performed by solving the LMI's given earlier together with a 100 element line search over logarithmically spaced  $\lambda$ . The Chen and Wen search is performed with a 18th order multiplier, comprising a 9th order causal and a 9th order anticausal part. Results are tested using the IQC toolbox [36].

The results of the various searches are shown in Table 2 for O'Shea's example using a variety of damping ratios,  $\zeta$ . For all  $\zeta$ , the Nyquist Value is infinite. As mentioned earlier, due to the symmetry in the example, Park's Criterion cannot out-perform the Circle Criterion, leading to identical maximum slope predictions from both criteria. Safonov and Chang's method gives the greatest slope value for  $\zeta = 0.6$ , but for the remaining  $\zeta$  gives values similar to Park/Circle. The remaining Zames–Falb searches all do better than Park for all values of  $\zeta$  and, perhaps not surprisingly given the phase symmetry of the problem, the causal and anticausal plant searches provide exactly the same slope values in all cases.

The structured search of Chen and Wen deserves some explanation: the performance of this technique is highly dependent on multiplier order. For  $\zeta \in [0.2, 0.6]$  with a 18th order multiplier, Chen and Wen's method took a similar computation time compared with other methods but provided significantly greater slope values. For higher order multipliers, the results deteriorate. This is likely to be due to numerical issues associated with the factorials in the basis representation. For  $\zeta < 0.05$ , Chen and Wen's method provided more conservative estimates of slope size, irrespective of multiplier order, than the plant order search. For low order

**Table 2**  
Maximum slope sizes predicted by search methods for various damping ratios in O'Shea's example. When  $\zeta > 0.5$  the maximum possible gain is infinite. The Nyquist value is infinity for all values of  $\zeta$ .

$\zeta$	Max slope for guaranteed stability							
	Circle	Park [62]	Plant order Zames–Falb searches				Safonov Chang et al. [17]	Structured ZF 18th order Chen and Wen [18]
			Causal Turner et al. [74]	Causal+Pop. Turner and Kerr [71]	Anticausal Carrasco et al. [16]	Anticausal+Pop. Carrasco et al. [16]		
0.6	11.52	11.52	19.9351	23.6229	19.9351	23.6229	399.6129	45.0599
0.55	9.6799	9.6799	17.1323	19.9064	17.1323	19.9064	9.6800	37.5353
0.5	8	8	14.5146	16.5478	14.5146	16.5478	8.0000	32.1810
0.45	6.48	6.48	12.0855	13.5025	12.0855	13.5025	6.4800	27.1045
0.4	5.12	5.12	9.849	10.7913	9.849	10.7913	5.1200	21.9573
0.35	3.92	3.92	7.8131	8.3913	7.8131	8.3913	3.9200	15.9843
0.3	2.88	2.88	5.9839	6.3238	5.9839	6.3238	2.8800	11.0796
0.25	2	2	4.352	4.5276	4.352	4.5276	2.0000	6.7336
0.05	0.08	0.08	0.2156	0.2165	0.2156	0.2165	0.0086	0.1916
0.01	0.0032	0.0032	0.0088	0.0088	0.0088	0.0088	0.0032	0.0034
0.005	0.0008	0.0008	0.0022	0.0022	0.0022	0.0022	0.0008	0.0007

multipliers this is due to the restricted bases  $(1/(s \pm 1)^N)$  used, while for high order multipliers numerical issues again become significant.

This suggests that results can be improved by a better selection of poles and this is indeed the case. Note that the IQC-toolbox can be used as a manual search tool by choosing an adequate location of the poles, hence the multiplier is given by

$$M(s) = 1 - \left( \sum_{i=0}^N \frac{\kappa_i^c}{(s+p_c)^{i+1}} + \sum_{i=0}^N \frac{\kappa_i^a}{(s-p_a)^{i+1}} \right) \quad (82)$$

for some selection  $p_c > 0$  and  $p_a > 0$ . For a discussion in the selection of these values, see [32]. An inexperienced user may perform the search using a swap over these two values or a Monte Carlo approach. However performance then depends on the user's ability. For example, when  $\zeta > 0.5$ , experienced users will understand that the phase of this plant requires a selection of the poles that concurs with the solution proposed by O'Shea: a very fast causal pole and an anticausal pole at  $-1$ . It does not seem surprising as O'Shea proposed such solution by hand 50 years ago.

O'Shea's example illustrates clearly the complexities in finding the "best" multiplier, and the current lack of a complete and tractable method.

### 6.7. Safonov's search

It is the first tractable search proposed in the literature, Safonov and Wyetzner [65] proposed a search where the parametrization of the multiplier contained irrational terms, i.e.

$$m(t) = \delta(t) - \sum_{i=1}^N z_i \delta(t - t_i).$$

The main advantage of this search is the simplicity to test the time domain condition. However, it is not possible to check the frequency domain condition in a convex manner. The lack of an LMI implementation reduces the usefulness of this search since it cannot straightforwardly be combined with other classes of multiplier.

Originally, the impulses were equally distributed over a range of times resulting in a large optimization problem. To reduce the computational burden, Gapski and Geromel [28] reduced the size of the optimization by proposing an iterative method where the position of a new impulse  $\delta(t - t_{N+1})$  is obtained if the search with  $N$  impulses fails. Recently, a new sub-algorithm has been proposed to improve this selection of the new impulse [17]. In Table 2, we

have used the code developed by Chang and Safonov.<sup>8</sup> The results for  $\zeta > 0.55$  are very good, but this search is not able to improve Circle criterion results for  $\zeta < 0.5$ . Once again, anti-symmetry of the phase of  $(1+kG)$  is a possible explanation. The search for the new  $t_{N+1}$  is designed to correct only one region of frequencies where there is a lack of positivity. So it is possible this the selected exponential for the multiplier is only able to "fix" one of both regions where there is lack of positivity. Note that as  $\zeta$  approaches zero, non-positive regions are closer each other.

## 7. Further developments

### 7.1. The IQC framework

We have framed our discussion in terms of passivity rather than IQCs (integral quadratic constraints) [54] which provided a new framework for multiplier theory. Whereas passivity, dissipativity, and Lyapunov theories can be used in any nonlinear interconnection, the IQC framework restricts its attention to the Lur'e system. It therefore provides a natural framework in which to work with Lur'e problems in general, and Zames–Falb multipliers in particular. Although Megretski and Rantzer [54] provide a self-contained frequency domain result, the IQC framework was developed in a combination of frequency and time domains by Yakubovich [87]. A natural extension of the original IQC framework to obtain stability conditions including Zames–Falb multipliers using convolution results in [23] has been developed in Altshuller et al. [4] and Altshuller [7].

Furthermore IQC theory provides not only self-contained stability results, but also computational tools to test stability conditions. For example, the search of Chen and Wen [18,19] is encapsulated within the IQC- $\beta$  toolbox [36,53]. The IQC framework is especially useful if there is more than one nonlinearity or uncertainty in a feedback loop (e.g. [34]); the motivating example of Section 2 is most naturally expressed in the IQC framework.

Zames–Falb multipliers were used as an illustrative example by Megretski and Rantzer [54]. This sparked renewed interest in their properties and applications. It is therefore worth asking what advantages the IQC framework offers over and above the user-friendliness noted above. IQC theory dispenses with the requirement that multipliers can be factorized, and this is often claimed

<sup>8</sup> Code is available on <http://www.michaelwchang.com/zf/>



as an advantage over classical methods [54]. But the requirement that the Zames–Falb multipliers must be factorizable is no restriction on their generality [89]. It turns out that this is also the case whenever multipliers are used for a class of nonlinearities that includes a finite gain [13]. On the other hand the IQC framework allows additional properties of the nonlinearities to be included in the analysis (for example [71] include a tighter sector condition); to the best of the authors' knowledge the results of such analysis cannot be obtained via classical techniques.

The relation between passivity theory and the IQC theorem is explored by Carrasco et al. [13]. The relation between dissipativity (and hence Lyapunov methods) and the IQC theorem is beginning to be understood [86,77,68,11].

## 7.2. MIMO nonlinearities

Similarly, our treatment has been restricted to SISO systems with slope restricted nonlinearities. The generalization of the Zames–Falb theorem to MIMO nonlinearities is discussed by Safonov and Kulkarni [66]. In particular, it is necessary that the nonlinearity can be expressed as the derivative of a convex potential function. This condition is natural for SISO nonlinearities, but may be restrictive in the MIMO case. In fact the condition was recognized in the classical literature [83]. It can be shown that the quadratic program used in input-constrained model predictive control satisfies the conditions for Zames–Falb multipliers [31]. Often attention is limited to diagonal nonlinearities; if the nonlinearities are repeated then the symmetry may be usefully exploited [21,40,72]. More generally, it is possible to construct specific multipliers appropriate for nonlinearities with repeated blocks [49].

## 7.3. Discrete-time multipliers

O'Shea also pioneered the equivalent multipliers for use with discrete-time systems [61]. Formal treatments can be found by [84] and [82]; their MIMO extension and necessity properties are given by Willems and Brockett [40] and Willems [49]. The discrete-time counterpart to the search for causal multipliers of Turner et al. [74] (and the anti-causal search of [16]) is developed by Ahmad et al. [2]. A search for a first-order FIR Zames–Falb multiplier is presented by Ahmad et al. [3]. A generalization to FIR Zames–Falb multipliers is presented by Wang et al. [81]. This approach appears highly promising, as it seems to combine the best aspects of the searches of Chen and Wen [18] and Safonov and Wyetzner [65]. To analyse the effectiveness of this method, the discrete counterpart of Lemma 4 by Megretski has been developed by Wang et al. [80]. An interesting application has been given in [44], where analysis and design of optimization algorithms have been carried out using Zames–Falb multipliers.

## 7.4. Different nonlinearities

Both Rantzer [64] and Materassi and Salapaka [51] allow relaxations on the condition of the nonlinearity. The nonlinearity considered in [64] is a perturbation of a nominal odd saturation function, while that considered by Materassi and Salapaka [51] is some perturbation of a more general nominal odd nonlinearity. In both cases positivity is preserved by further limiting the  $\mathcal{L}_1$  norm condition. The multipliers of Rantzer [64] can be shown to be applicable to a wider class of nonlinearity [42,41].

## 8. Open questions

Although there have been many recent advances in Zames–Falb multiplier theory, some questions are still open even for SISO

systems in continuous-time. Here we provide some of these open questions.

*Complete search:* Different searches have been proposed in the literature. Results in this paper and comparisons by Carrasco et al. [15] show that no complete tractable search can be found in the literature. Advantages and drawbacks of each technique have been mentioned in Section 6. The development of a complete and tractable search remains an open challenge.

*Instability criteria:* Currently, searches are tested using only the Nyquist value as an upper bound. However, it is well known that this is not a tight bound for fourth-order systems or higher order. For O'Shea's example small values of  $\zeta$  produce unstable behavior. The maximum slope for searches decreases significantly as  $\zeta$  approaches zero, though the Nyquist value remains infinity. In discrete-time, second-order counterexamples to the Kalman conjecture are given by Heath et al. [30], so the Nyquist values is only tight in general for first order systems. Tractable instability criteria must be developed to be able to understand the real conservativeness of the classes of multipliers and searches over these classes. Existence of limit cycles for this particular problem is discussed by Leonov and Kuznetsov [46], whereas general results are also available in the literature (e.g. [50]).

*Dual problem:* The dual problem in robustness analysis has been proposed by Jönsson [32] and Jönsson and Rantzer [33]. The limitations given by Megretski [52] provide a method to find when a Zames–Falb multiplier cannot be found. However, it is not understood how to use these limitations to discard the existence of a Zames–Falb multiplier suitable for a plant  $G$  and slope  $k$ .

*Stability conjecture:* Related with the two previous questions, we can state the following conjecture:

**Conjecture 1.** *Suppose we have a stable plant  $G$  and a constant  $k < k_N$  such that there is no Zames–Falb multiplier  $M$  satisfying*

$$\operatorname{Re}\{M(j\omega)(1+kG(j\omega))\} \geq \delta$$

*for any  $\delta > 0$ . Then there exists a slope-restricted nonlinearity  $\phi \in S[0, k]$  such that the feedback interconnection between  $G$  and  $\phi$  is not  $\mathcal{L}_2$ -stable.*

*Completeness:* In discrete-time, the Zames–Falb multipliers are the only multipliers that can preserve the positivity of monotone and bounded nonlinearities [83,40,49]. In continuous time other multipliers, such as Popov multipliers, can also preserve the positivity of the nonlinearity yet are not themselves Zames–Falb multipliers. Nevertheless, all other classes of multipliers in the literature have been shown to be phase-equivalent to Zames–Falb multipliers [14,15]. It is an open question whether any possible class of multipliers preserving the positivity of monotone and bounded nonlinearities is phase-contained in the class of Zames–Falb multipliers.

*Synthesis:* The use of multipliers for synthesis has already been proposed by Veenman and Scherer [78]. Moreover, Zames–Falb multipliers have been already used in synthesis techniques [57,37]. The development of a convex synthesis technique using the Zames–Falb multipliers for anti-windup design is still open.

*Local stability:* The use of input–output stability criteria provides many advantages. However, open-loop unstable systems only can be locally stable in closed-loop. The use of IQCs for local stability has been considered by Fang et al. [25]. However, it is unknown whether multiplier theory has any role in the analysis of local stability.

## 9. Conclusion

This tutorial has attempted to provide a coherent introduction to the topic of Zames–Falb multipliers. We have shown a

motivating example for using Zames–Falb multipliers in the robustness analysis of antiwindup. Their definitions, phase properties, and searches have been presented.

We have devoted a significant part of the paper to describing O'Shea's contribution, most notably O'Shea's observation that noncausal multipliers provide significant advantages over causal multipliers, in particular with respect to their phase properties. We have also shown, using O'Shea's original set of examples, the complexity in multiplier searches: for some ( $\zeta > 0.5$ ), a manual search remains best; while for others ( $\zeta < 0.5$ ) the best achievable slope remains unknown and for different values of  $\zeta$  different automated searches appear better.

## Acknowledgements

The authors thank Prof. M. Vidyasagar for his comments on the historical part of this tutorial. The work of J. Carrasco and W. Heath has been funded by EPSRC Grant EP/H016600/1.

## Appendix A. Further notation

This appendix provides some technicalities about common notation in multiplier theory that has been used tacitly in the main text.

### A.1. Signal spaces

Let  $\mathcal{L}_2(-\infty, \infty)$  be the Hilbert space of all square integrable and Lebesgue measurable functions (usually signals)  $f : (-\infty, \infty) \rightarrow \mathbb{R}$  with inner product defined as

$$\langle f, g \rangle = \int_{-\infty}^{\infty} f(t)g(t) dt, \quad (\text{A.1})$$

and norm defined as  $\|f\|_2 = \langle f, f \rangle^{1/2}$ , for  $f, g \in \mathcal{L}_2(-\infty, \infty)$ . The function  $f \in \mathcal{L}_2(-\infty, \infty)$  belongs to the subspace  $\mathcal{L}_2[0, \infty)$  if  $f(t) = 0$  for all  $t < 0$  and the subspace  $\mathcal{L}_2(-\infty, 0]$  if  $f(t) = 0$  for all  $t > 0$ . For brevity we often use  $f \in \mathcal{L}_2$  as shorthand for  $f \in \mathcal{L}_2[0, \infty)$ . A truncation of the function  $f$  at  $T$  is given by  $f_T(t) = f(t)$ ,  $\forall t \leq T$  and  $f_T(t) = 0$ ,  $\forall t > T$ . The function  $f$  belongs to the extended space  $\mathcal{L}_{2e}[0, \infty)$  if  $f_T \in \mathcal{L}_2[0, \infty)$  for all  $T > 0$ .

Let  $\mathcal{L}_1(-\infty, \infty)$  be the space of all absolutely integrable and Lebesgue measurable functions (usually impulse responses of LTI systems)  $f : (-\infty, \infty) \rightarrow \mathbb{R}$  with norm

$$\|f\|_1 = \int_{-\infty}^{\infty} |f(t)| dt. \quad (\text{A.2})$$

The function  $f \in \mathcal{L}_1(-\infty, \infty)$  belongs to the subspace  $\mathcal{L}_1[0, \infty)$  if  $f(t) = 0$  for all  $t < 0$  and the subspace  $\mathcal{L}_1(-\infty, 0]$  if  $f(t) = 0$  for all  $t > 0$ . For brevity we often use  $f \in \mathcal{L}_1$  as shorthand for  $f \in \mathcal{L}_1[-\infty, \infty)$ .

### A.2. System spaces

The space  $\mathbf{L}_\infty(\mathbf{RL}_\infty)$  is the space of (real rational) transfer functions,  $G(s)$ , bounded and analytic on the imaginary axis. The  $\mathbf{L}_\infty$ -norm is defined as

$$\|G\|_\infty = \sup_{\omega \in (-\infty, \infty)} |G(j\omega)|$$

The space  $\mathbf{H}_\infty(\mathbf{RH}_\infty)$  is the space of (real rational) transfer functions analytic in the closed right half plane. The space  $\mathbf{H}_\infty^-(\mathbf{RH}_\infty^-)$  is the space of (real rational) transfer functions analytic in the closed left half plane.

It can be shown, for  $G \in \mathbf{RH}_\infty$ , that

$$\|G\|_\infty = \sup_{w \in \mathcal{L}_2[0, \infty), w \neq 0} \frac{\|Gw\|_2}{\|w\|_2} \quad (\text{A.3})$$

A system  $G$  is said to be causal if  $(Gu)_T = (Gu_T)_T$  for any  $T > 0$ . A formal definition of anticausal system would require a different truncation, but an LTI operator is anticausal if its adjoint is causal. If an LTI operator has a bounded impulse response  $h(t)$ , i.e.  $h \in \mathcal{L}_1$ , its transfer function belongs to  $\mathbf{H}_\infty(\mathbf{H}_\infty^-)$  if and only if  $h(t) = 0$  for all  $t < 0$  ( $t > 0$ ), i.e. the LTI operator is causal (anticausal).

### A.3. Nonlinearities

A nonlinearity  $\phi : \mathcal{L}_{2e}[0, \infty) \rightarrow \mathcal{L}_{2e}[0, \infty)$  is said to be memoryless if there exists  $N : \mathbb{R} \rightarrow \mathbb{R}$  such  $(\phi v)(t) = N(v(t))$  for all  $t \in \mathbb{R}$ . We assume that  $N(0) = 0$ . Moreover,  $\phi$  is slope-restricted in the interval  $S[0, k]$ , if

$$0 \leq \frac{N(x_1) - N(x_2)}{x_1 - x_2} \leq k \quad (\text{A.4})$$

for all  $x_1 \neq x_2$ . The nonlinearity  $\phi$  is said to be odd if  $N(x) = -N(-x)$  for all  $x \in \mathbb{R}$ . Let  $\Phi(k)$  be the class of slope-restricted nonlinearities with slope within the interval  $S[0, k]$ . Our prime example is a saturation function, which is slope-restricted to the interval  $S[0, 1]$ . A saturation function in series with a linear gain  $k$  is a memoryless nonlinearity slope-restricted to the interval  $S[0, k]$ . It is odd if the absolute value of the upper bound is equal to the absolute value of the lower bound.

## References

- [1] J. Abedor, K. Nagpal, K. Poolla, A linear matrix inequality approach to peak-to-peak gain minimization, *Int. J. Robust Nonlinear Control* 6 (9–10) (1996) 899–927.
- [2] N. Ahmad, J. Carrasco, W. Heath, LMI searches for discrete-time Zames–Falb multipliers, in: *IEEE 52nd Annual Conference on Decision and Control*, 2013, pp. 5258–5263.
- [3] N. Ahmad, J. Carrasco, W. Heath, A less conservative LMI condition for stability of discrete-time systems with slope-restricted nonlinearities, *IEEE Trans. Autom. Control* 60(6) (2015) 1692–1697.
- [4] D. Altschuller, A. Proskurnikov, V. Yakubovich, Frequency-domain criteria for dichotomy and absolute stability for integral equations with quadratic constraints involving delays, *Dokl. Math.* 2004 (70) (2004) 998–1002.
- [5] D. Altschuller, Frequency-domain criteria for robust stability for a class of linear time-periodic systems, in: *The 2010 American Control Conference*, 2010, pp. 4247–4252.
- [6] D.A. Altschuller, Delay-integral-quadratic constraints and stability multipliers for systems with MIMO nonlinearities, *IEEE Trans. Autom. Control* 56 (4) (2011) 738–747.
- [7] D.A. Altschuller, *Frequency Domain Criteria for Absolute Stability*, Springer, London, 2013.
- [8] N.E. Barabanov, On the Kalman problem, *Sib. Math. J.* 29 (1988) 333–341.
- [9] R. Brockett, J.L. Willems, Frequency domain stability criteria—Part i, *IEEE Trans. Autom. Control* 10 (3) (1965) 255–261.
- [10] B. Brogliato, B. Maschke, R. Lozano, O. Egeland, *Dissipative Systems Analysis and Control: Theory and Applications*, Springer, London, 2006.
- [11] J. Carrasco, P. Seiler, Integral quadratic constraint theorem: a topological separation approach, in: *54th IEEE Conference on Decision and Control*, 2015.
- [12] J. Carrasco, W. Heath, G. Li, A. Lanzon, Comments on “On the existence of stable, causal multipliers for systems with slope-restricted nonlinearities”, *IEEE Trans. Autom. Control* 57 (9) (2012) 2422–2428.
- [13] J. Carrasco, W.P. Heath, A. Lanzon, Factorization of multipliers in passivity and IQC analysis, *Automatica* 48 (5) (2012) 609–616.
- [14] J. Carrasco, W.P. Heath, A. Lanzon, Equivalence between classes of multipliers for slope-restricted nonlinearities, *Automatica* 49 (6) (2013) 1732–1740.
- [15] J. Carrasco, W.P. Heath, A. Lanzon, On multipliers for bounded and monotone nonlinearities, *Syst. Control Lett.* 66 (2014) 65–71.
- [16] J. Carrasco, M. Maya-Gonzalez, A. Lanzon, W.P. Heath, LMI searches for anticausal and noncausal rational Zames–Falb multipliers, *Syst. Control Lett.* 70 (2014) 17–22.
- [17] M. Chang, R. Mancera, M. Safonov, Computation of Zames–Falb multipliers revisited, *IEEE Trans. Autom. Control* 57 (4) (2012) 1024–1029.
- [18] X. Chen, J. Wen, Robustness analysis of LTI systems with structured incrementally sector bounded nonlinearities, in: *Proceedings of the American Control Conference*, vol. 5, 1995, pp. 3883–3887.

- [19] X. Chen, J. Wen, Robustness analysis for linear time-invariant systems with structured incrementally sector bounded feedback nonlinearities, *Appl. Math. Comput. Sci.* 6 (1996) 623–648.
- [20] Y.-S. Cho, K. Narendra, An off-axis circle criterion for stability of feedback systems with a monotonic nonlinearity, *IEEE Trans. Autom. Control* 13 (4) (1968) 413–416.
- [21] F.J. D'Amato, M.A. Rotea, A.V. Megretski, U.T. Jönsson, New results for analysis of systems with repeated nonlinearities, *Automatica* 37 (5) (2001) 739–747.
- [22] C.A. Desoer, M. Vidyasagar, *Feedback Systems: Input–Output Properties*, Academic Press, Inc., Orlando, FL, USA, 1975.
- [23] P. Falb, G. Zames, On cross-correlation bounds and the positivity of certain nonlinear operators, *IEEE Trans. Autom. Control* 12 (2) (1967) 219–221.
- [24] P. Falb, G. Zames, Multipliers with real poles and zeros: an application of a theorem on stability conditions, *IEEE Trans. Autom. Control* 13 (1) (1968) 125–126.
- [25] H. Fang, Z. Lin, M. Rotea, On IQC approach to the analysis and design of linear systems subject to actuator saturation, *Syst. Control Lett.* 57 (8) (2008) 611–619.
- [26] R. Fitts, Two counterexamples to Aizerman's conjecture, *IEEE Trans. Autom. Control* 11 (3) (1966) 553–556.
- [27] M.I. Freedman, Phase function norm estimates for stability of systems with monotone nonlinearities, *SIAM J. Control* 10 (1) (1972) 99–111.
- [28] P. Gapski, J. Geromel, A convex approach to the absolute stability problem, *IEEE Trans. Autom. Control* 39 (9) (1994) 1929–1932.
- [29] T. Georgiou, M. Smith, Intrinsic difficulties in using the doubly-infinite time axis for input–output control theory, *IEEE Trans. Autom. Control* 40 (3) (1995) 516–518.
- [30] W.P. Heath, J. Carrasco, M. de la Sen, Second-order counterexamples to the discrete-time Kalman conjecture, *Automatica* 60 (2015) 140–144.
- [31] W.P. Heath, A.G. Wills, Zames–Falb multipliers for quadratic programming, *IEEE Trans. Autom. Control* 52 (10) (2007) 1948–1951.
- [32] U.T. Jönsson, Robustness analysis of uncertain and nonlinear systems (Ph.D. dissertation), Department of Automatic Control, Lund Institute of Technology, 1996.
- [33] U. Jönsson, A. Rantzer, Duality bounds in robustness analysis, *Automatica* 33 (10) (1997) 1835–1844.
- [34] U.T. Jönsson, A. Rantzer, *Optimization of Integral Quadratic Constraints, Society for Industrial and Applied Mathematics*, Philadelphia, PA, USA, 2000, pp. 109–127 (Chapter 6).
- [35] R.E. Kalman, Physical and mathematical mechanisms of instability in nonlinear automatic control systems, *Trans. ASME* 79 (3) (1957) 553–566.
- [36] C.-Y. Kao, A. Megretski, U.T. Jonsson, A. Rantzer, A MATLAB toolbox for robustness analysis, in: *IEEE International Symposium on Computer Aided Control Systems Design*, 2004, pp. 297–302.
- [37] M. Kerr, M.C. Turner, E. Villota, S. Jayasuriya, I. Postlethwaite, A robust anti-windup design procedure for SISO systems, *Int. J. Control* 84 (2) (2011) 351–369.
- [38] H.K. Khalil, *Nonlinear Systems*, Prentice-Hall, Upper Saddle River, (2002) NJ 07458.
- [39] M.V. Kothare, M. Morari, Multiplier theory for stability analysis of anti-windup control systems, *Automatica* 35 (5) (1999) 917–928.
- [40] V. Kulkarni, M. Safonov, All multipliers for repeated monotone nonlinearities, *IEEE Trans. Autom. Control* 47 (7) (2002) 1209–1212.
- [41] V.V. Kulkarni, L.Y. Pao, M.G. Safonov, On stability analysis of systems featuring a multiplicative combination of nonlinear and linear time-invariant feedback, *Int. J. Robust Nonlinear Control* 21 (18) (2011) 2101–2108.
- [42] V.V. Kulkarni, L.Y. Pao, M.G. Safonov, Positivity preservation properties of the Rantzer multipliers, *IEEE Trans. Autom. Control* 56 (1) (2011) 190–194.
- [43] N.V. Kuznetsov, G.A. Leonov, S.M. Seledzhi, Hidden oscillations in nonlinear control systems, *IFAC Proc. Vol.* 18 (1) (2011) 2506–2510.
- [44] L. Lessard, B. Recht, A. Packard, *Analysis and Design of Optimization Algorithms via Integral Quadratic Constraints*, 2015, arXiv:1408.3595.
- [45] G.A. Leonov, N.V. Kuznetsov, Analytical-numerical methods for investigation of hidden oscillations in nonlinear control systems, *IFAC Proc. Vol.* 18 (1) (2011) 2494–2505.
- [46] G. Leonov, N. Kuznetsov, Hidden attractors in dynamical systems from hidden oscillations in Hilbert–Kolmogorov, Aizerman, and Kalman problems to hidden chaotic attractor in Chua circuits, *Int. J. Bifurc. Chaos* 23 (10) (2013) 1330002.
- [47] M. Liberzon, Essays on the absolute stability theory, *Autom. Remote Control* 67 (10) (2006) 1610–1644.
- [48] A.V. Lipatov, Stability of continuous systems with one nonlinearity, *Dokl. Akad. Nauk SSSR* 267 (1981) 1069–1072.
- [49] R. Mancera, M.G. Safonov, All stability multipliers for repeated MIMO nonlinearities, *Syst. Control Lett.* 54 (4) (2005) 389–397.
- [50] I.R. Manchester, J.-J.E. Slotine, Transverse contraction criteria for existence, stability, and robustness of a limit cycle, *Syst. Control Lett.* 63 (2014) 32–38.
- [51] D. Materassi, M. Salapaka, A generalized Zames–Falb multiplier, *IEEE Trans. Autom. Control* 56 (6) (2011) 1432–1436.
- [52] A. Megretski, Combining  $\mathcal{L}_1$  and  $\mathcal{L}_2$  methods in the robust stability and performance analysis of nonlinear systems, in: *Proceedings of the 34th IEEE Conference on Decision and Control*, 1995, pp. 3176–3181.
- [53] A. Megretski, C. Kao, U. Jonsson, A. Rantzer, *A Guide to IQC- $\beta$ : A MATLAB Toolbox for Robust Stability and Performance Analysis*, Technical Report, MIT, 2004.
- [54] A. Megretski, A. Rantzer, System analysis via integral quadratic constraints, *IEEE Trans. Autom. Control* 42 (6) (1997) 819–830.
- [55] R. Morales, G. Li, W. Heath, Anti-windup and the preservation of robustness against structured norm-bounded uncertainty, *Int. J. Robust Nonlinear Control* 24 (17) (2014) 2640–2652.
- [56] M. Morari, E. Zafriou, *Robust Process Control*, Prentice-Hall International, Englewood Cliffs, NJ, 1989.
- [57] J.C. Moreno, A.B. Baños, M. Berenguel, A QFT framework for antiwindup control systems design, *J. Dyn. Syst. Meas. Control* 132 (2) (2010) 021012.
- [58] K. Narendra, J. Taylor, *Frequency Domain Criteria for Absolute Stability*, Academic Press, New York, London, 1973.
- [59] R. O'Shea, A combined frequency–time domain stability criterion for autonomous continuous systems, *IEEE Trans. Autom. Control* 11 (3) (1966) 477–484.
- [60] R. O'Shea, An improved frequency time domain stability criterion for autonomous continuous systems, *IEEE Trans. Autom. Control* 12 (6) (1967) 725–731.
- [61] R. O'Shea, M. Younis, A frequency–time domain stability criterion for sampled-data systems, *IEEE Trans. Autom. Control* 12 (6) (1967) 719–724.
- [62] P. Park, Stability criteria of sector- and slope-restricted Lur'e systems, *IEEE Trans. Autom. Control* 47 (2) (2002) 308–313.
- [63] A. Rantzer, On the Kalman–Yakubovich–Popov lemma, *Syst. Control Lett.* 28 (1) (1996) 7–10.
- [64] A. Rantzer, Friction analysis based on integral quadratic constraints, *Int. J. Robust Nonlinear Control* 11 (7) (2001) 645–652.
- [65] M. Safonov, G. Wyetzner, Computer-aided stability analysis renders Popov criterion obsolete, *IEEE Trans. Autom. Control* 32 (12) (1987) 1128–1131.
- [66] M.G. Safonov, V.V. Kulkarni, Zames–Falb multipliers for MIMO nonlinearities, *Int. J. Robust Nonlinear Control* 10 (11–12) (2000) 1025–1038.
- [67] C. Scherer, P. Gahinet, M. Chilali, Multiobjective output-feedback control via LMI optimization, *IEEE Trans. Autom. Control* 42 (7) (1997) 896–911.
- [68] P. Seiler, Stability analysis with dissipation inequalities and integral quadratic constraints, *IEEE Trans. Autom. Control* 60 (6) (2015) 1704–1709.
- [69] G. Szegő, *Orthogonal Polynomials*, American Mathematical Society, Providence, RI, 1975.
- [70] The Tribune-Democrat, *Obituary of Richard P. O'Shea*: <http://www.tribdem.com/archives/richard-paul-o-shea-ph-d/article%208ab76949-87f8-5652-b9f6-64d6d3f2b951.html>, 2009, Retrieved: 31/10/14.
- [71] M.C. Turner, M.L. Kerr,  $\mathcal{L}_2$  gain bounds for systems with sector bounded and slope-restricted nonlinearities, *Int. J. Robust Nonlinear Control* 22 (13) (2011) 1505–1521.
- [72] M. Turner, M.L. Kerr, J. Sofrony, Tractable stability analysis for systems containing repeated scalar slope-restricted nonlinearities, *Int. J. Robust Nonlinear Control* 25 (7) (2015) 971–986.
- [73] M. Turner, G. Hermann, I. Postlethwaite, Incorporating robustness requirements into antiwindup design, *IEEE Trans. Autom. Control* 52 (10) (2007) 1842–1855.
- [74] M.C. Turner, M.L. Kerr, I. Postlethwaite, On the existence of stable, causal multipliers for systems with slope-restricted nonlinearities, *IEEE Trans. Autom. Control* 54 (11) (2009) 2697–2702.
- [75] M. Turner, M.L. Kerr, I. Postlethwaite, J. Sofrony,  $\mathcal{L}_2$  gain bounds for systems with slope-restricted nonlinearities, in: *American Control Conference (ACC)*, 2010, pp. 22671–2676.
- [76] M. Turner, M.L. Kerr, I. Postlethwaite, Authors reply to “Comments on ‘On the existence of stable, causal multipliers for systems with slope-restricted nonlinearities’”, *IEEE Trans. Autom. Control* 57 (9) (2012) 2428–2430.
- [77] J. Veenman, C.W. Scherer, Stability analysis with integral quadratic constraints: a dissipativity based proof, in: *52nd IEEE Conference on Decision and Control*, 2013, pp. 3770–3775.
- [78] J. Veenman, C.W. Scherer, IQC-synthesis with general dynamic multipliers, *Int. J. Robust Nonlinear Control* 24 (17) (2014) 3027–3056.
- [79] M. Vidyasagar, *Nonlinear Systems Analysis*, Prentice-Hall International, Englewood Cliffs, NJ, 1993.
- [80] S. Wang, J. Carrasco, W.P. Heath, Phase limitations of discrete-time Zames–Falb multipliers, in: *54th IEEE Conference on Decision and Control*, 2015.
- [81] S. Wang, W.P. Heath, J. Carrasco, A complete and convex search for discrete-time noncausal FIR Zames–Falb multipliers, in: *53rd IEEE Conference on Decision and Control*, 2014, pp. 3918–3923.
- [82] J.C. Willems, *The Analysis of Feedback Systems*, The MIT Press, Clinton, Massachusetts, 1971.
- [83] J.C. Willems, Dissipative dynamical systems. Part I: general theory, *Arch. Ration. Mech. Anal.* 45 (1972) 321–351.
- [84] J.C. Willems, R. Brockett, Some new rearrangement inequalities having application in stability analysis, *IEEE Trans. Autom. Control* 13 (5) (1968) 539–549.
- [85] J.C. Willems, M. Gruber, R. O'Shea, Comments on “A combined frequency–time domain stability criterion for autonomous continuous systems”, *IEEE Trans. Autom. Control* 12 (2) (1967) 217–219.
- [86] J.C. Willems, K. Takaba, Dissipativity and stability of interconnections, *Int. J. Robust Nonlinear Control* 17 (5–6) (2007) 563–586.
- [87] V. Yakubovich, Frequency conditions for the absolute stability and dissipativity of control systems with a single differentiable nonlinearity, *Sov. Math. Dokl.* 6 (1965) 98–101.
- [88] G. Zames, P. Falb, On the stability of systems with monotone and odd monotone nonlinearities, *IEEE Trans. Autom. Control* 12 (2) (1967) 221–223.
- [89] G. Zames, P.L. Falb, Stability conditions for systems with monotone and slope-restricted nonlinearities, *SIAM J. Control* 6 (1) (1968) 89–108.
- [90] A. Zheng, M.V. Kothare, M. Morari, Anti-windup design for internal model control, *Int. J. Control* 60 (5) (1994) 1015–1024.